

32640

INFRASTRUCTURE IN LATIN AMERICA & THE CARIBBEAN:

Recent Developments and Key Challenges

Marianne Fay
and Mary Morrison

In Two Volumes
Volume I: Main Report
Report No. 32640-LCR



THE WORLD BANK
FINANCE, PRIVATE SECTOR AND INFRASTRUCTURE UNIT
LATIN AMERICA & THE CARIBBEAN REGION



Table of contents

ACRONYMS AND ABBREVIATIONS	4
ACKNOWLEDGMENTS	6
ABSTRACT	7
OVERVIEW	i
INFRASTRUCTURE IN LAC – SOME PROGRESS, BUT NOT ENOUGH	1
Coverage and quality have improved, but slowly.....	1
Slow infrastructure gains imply reduced growth and competitiveness	3
The fight against poverty and inequality has also been hampered	8
AT ISSUE: INSUFFICIENT IMPROVEMENT IN THE MANAGEMENT OF TOO FEW RESOURCES	10
Private entry could not make up for public retrenchment.....	10
Who or what is to blame for the growing disenchantment with PPI?	15
<i>The impact of PPI has been mixed, but positive overall</i>	15
<i>However, there have been too many renegotiations and some well publicized failures</i>	17
<i>The process has suffered from macro shocks and poor management of the political economy of reform</i>	20
The critical issues: cost recovery and governments’ regulatory and redistributive functions.....	23
<i>PPI sometimes occurred amid incomplete reforms and immature regulatory frameworks</i>	23
<i>Cost recovery has proved elusive</i>	25
<i>Poorly designed social tariffs hinder cost recovery and do too little for the poor</i>	28
KEY CHALLENGES	32
Improving the social and economic returns from infrastructure.....	32
<i>Finding better ways to extend affordable service to the poor</i>	32
<i>Improving public infrastructure spending efficiency</i>	35
Managing PPI better	37
<i>Getting the sequencing of reform and PPI right</i>	37
<i>A stronger state role: new forms of Public-Private Partnership</i>	38
<i>Improving award processes and the design of concessions</i>	39
<i>Managing and allocating risks better</i>	40
<i>Enhancing the capacity of regulators and other institutions</i>	41
<i>Choosing the right regulatory regime</i>	42
Raising new finance for infrastructure.....	43
<i>The scope for further funding through user charges</i>	43
<i>Improving risk coverage, to attract back private investors</i>	46
<i>Drawing more from local capital markets</i>	48
<i>The case for more public investment in infrastructure</i>	50
<i>Improving local governments’ access to funding</i>	52
REFERENCES	57

List of Figures

Figure 1: Latin America has lost ground against the East Asian Tigers, China and Middle Income Countries	iii
Figure 2: Primary deficit and public infrastructure investment (% of GDP).....	iv
Figure 3: Privatization has become very unpopular in Latin America	iv
Figure 4: Businesses that see infrastructure as a serious problem	6
Figure 5: Productivity gains from a 20% improvement in selected investment climate variables by country (percent)	7
Figure 6: Infrastructure investment in major countries (percentage of GDP)	11
Figure 7: The different forms of PPI in LAC (1990 to 2003).....	12
Figure 8: Changing forms of PPI in LAC since 1990 (by project count).....	13
Figure 9: Population expressing dissatisfaction with privatizations (percentage).....	15
Figure 10: Urban households facing affordability problems by country	44
Figure 11: Urban households facing affordability problems by country (PPP).....	45

List of Tables

Table 1: Infrastructure coverage in LAC, China and middle income countries	1
Table 2: Piped water connections, by expenditure quintiles.....	3
Table 3: Potential growth improvement in LAC countries due to infrastructure development.....	5
Table 4: Changes of inequality (Gini coefficient) in LAC countries due to higher infrastructure development	9
Table 5: The contribution of infrastructure to fiscal adjustment, average 1980-84 vs average 1995-98.....	12
Table 6: Overview of average residential water tariffs.....	27
Table 7: Overview of average residential electricity tariffs.....	28
Table 8: Main project risks in emerging market infrastructure	41

List of Boxes

Box 1: Infrastructure, productivity and growth: what the literature says	4
Box 2: The uneven pace of reform across sectors	14
Box 3: Definition of concessions.....	18
Box 4: Some examples of government-induced concession disputes	19
Box 5: Hidden failures and perception management: explanations for social discontent about privatization	22
Box 6: Colombia's experience with raising residential water tariffs.....	30
Box 7: Pilot program to use output-based aid for expanding water coverage in Paraguay	33
Box 8: Peru Rural Roads Projects.....	37
Box 9: OPIC's Liquidity Facility to protect bonds in the AES Tiête project, Brazil, from foreign exchange risk.....	47
Box 10: IFC partial risk guarantee for bond issue by Triple A, Colombia.....	48
Box 11: Tapping pension funds through bond sales, to finance infrastructure in Chile... ..	50
Box 12: Best and worst practices with significant rating value for Fitch.....	52
Box 13: Paranacidade: Linking municipal finance to capacity building	55
Box 14: Local currency financing for Mexico sub-national infrastructure needs	56

ACRONYMS AND ABBREVIATIONS

BOT	Build-operate-transfer
EAP	East Asia and the Pacific
GDP	Gross domestic product
IADB	Inter-American Development Bank
IBRD	International Bank for Reconstruction and Development
IFC	International Finance Corporation
IFIs	International financial institutions
LAC	Latin America and the Caribbean
MICs	Middle-income countries
OECD	Organization for Economic Cooperation and Development
OPIC	Overseas Private Investment Corporation
PAHO	Pan-American Health Organization
PPI	Private Participation in infrastructure
PPP	Public-private partnerships
PCG	Partial credit guarantees
PRG	Partial risk guarantee
UNICEF	United Nations Children's Fund
USO	Universal Service Obligation
WHO	World Health Organization
WSS	Water Supply and Sanitation

ACKNOWLEDGMENTS

This report is part of a joint initiative of the Inter-American Development Bank and the World Bank to examine infrastructure issues in Latin America and the Caribbean. This has entailed commissioning a number of background papers to explore areas on which more information was needed (fiscal space, cost recovery, infrastructure finance, public discontent with private participation in infrastructure) as well as a number of country studies. It has also included a conference on June 6th and 7th on the Diagnosis and Challenges of Economic Infrastructure in Latin America.

The main authors of this report are Marianne Fay and Mary Morrison but this work has also benefited from close collaboration with Nicolas Peltier-Thiberge, as well as with Paulina Beato and Juan Benavides from the Inter-American Development Bank.

The team is grateful to the following for their comments, suggestions and inputs: Luis Alberto Andres, Antonella Bassani, Antonio Estache, Susan Goldmark, Abhas Jha, Ellis Juan, Demetrios Papathanasiou, Guillermo Perry, Tomás Serebrisky, Jordan Schwartz, Sophie Sirtaine, Manuel Schiffler, Adam Schwartzman, Rob Stevens, Carlos Velez, Eloy Vidal, and Tito Yepes; and to Julieta Abad who managed the production of this report.

The authors also wish to thank Cesar Calderón, Antonio Estache, Vivien Foster, Luis Guasch and Luis Servén on whose body of work this report draws extensively.

ABSTRACT

In the last decade, most countries in Latin America and the Caribbean have not spent enough on infrastructure. Total investment has fallen as a percentage of GDP, as public infrastructure expenditure has borne the brunt of fiscal adjustment, and private investment has failed to take up the slack.

Most infrastructure services have therefore lagged behind East Asian comparators, middle income countries in general and China, in terms of both coverage and quality, despite the generally positive impacts of private sector involvement. This lackluster performance has slowed LAC's economic growth and progress in poverty reduction.

Countries of the region therefore need to focus on upgrading their infrastructure, as this can yield great dividends in terms of growth, competitiveness and poverty reduction, as well as improving the quality of life of their citizens. Catching up requires significant new investment. But first, measures need to be taken to ensure that infrastructure spending produces higher returns, both economic and social. Both these tasks involve multiple challenges.

Public investment should be better allocated, with greater priority given to maintenance and rehabilitation against higher profile new projects. Small-scale local providers and cheaper technologies should be used for infrastructure work and services where appropriate. The considerable state resources already spent on subsidies, especially for water and electricity, need to be radically retargeted, to benefit fewer of the non-poor and more of those in need. More active policies are also needed to extend affordable coverage to rural areas and the urban poor, many of whom remain underserved.

Considerable further financing will also be necessary. There is scope in many countries for user charges to generate more funding, particularly in the water and electricity sectors. Raising tariffs to cost recovery levels would be affordable to the great majority of the population in most countries, and a more effective application of the funds currently spent on subsidies would protect low-income groups.

To reinvigorate private sector investment, governments need to find ways to make the risk-return ratio of projects more attractive. Improving contract design, making award processes more transparent and competitive and strengthening regulation will promote efficiency and better service, address investor concerns and reduce the cost of capital through lower regulatory risk. Such moves will also help reduce the renegotiation of concessions, which has been too frequent in Latin America and has damaged the credibility of contracting.

However, greater care must go into risk management, and the correct identification and allocation of risks in concessions. State guarantees can be useful for attracting the private sector, but ill-considered commitments made in the past, sometimes using unrealistic demand projections or excessive compensation schedules have exposed governments to enormous contingent liabilities.

Public opposition also represents a significant challenge to private sector involvement, politically and sometimes even operationally. Better subsidies, stronger and more transparent contract awards and regulation, as well as macroeconomic strengthening, are all likely to improve sentiment. Governments also need to improve the public perception of privatization, by making

sure that the job losses and tariff hikes that reforms may involve do not coincide, and become associated, with private entry. But they also need to avoid creating unrealistic expectations of the benefits that private involvement may bring.

Amid continuing caution from international investors toward emerging markets, governments will also need to tap other sources to meet their infrastructure funding needs. Greater use can be made of local capital markets, if instruments are designed creatively. And while few governments currently have much room in their budgets for additional infrastructure investment, the great potential returns of many infrastructure projects in the long-term may warrant increases in allocations in many countries.

OVERVIEW

This report is about infrastructure in Latin America and the Caribbean (LAC) and the extraordinary transformations that have shaped it over the last 15 years. It is about the false hopes and disappointed expectations that have surrounded private sector participation, and also about the progress made and the lessons learnt. It is about an upper middle income region whose infrastructure coverage has fallen below the middle income average, despite its attracting more private investment in infrastructure than any other developing region.

Infrastructure is hampering LAC's ability to grow, compete and reduce poverty. This has happened as the governments of the region have largely offloaded responsibility for reform and finance to the private sector, or simply let sectors deplete capital. More than a decade ago, a key conclusion of the 1994 World Development Report on Infrastructure for Development was that public-private partnerships in financing had promise but governments had a continuing, if changed, role to play in infrastructure. Today's analysis of infrastructure in Latin America and the Caribbean only reinforces those conclusions.

This report has four key messages:

- **LAC needs to spend more on infrastructure.** The region is spending less than 2% of GDP on infrastructure – but 4 - 6% per annum is needed if it is to catch up or keep up with countries that once trailed it, such as Korea or China. Infrastructure costs must be borne by either users or taxpayers, regardless of how these are financed. So the implication is that cost recovery from users must improve. This entails changing the payment culture as well as putting in place effective provisions to protect those who really cannot afford to pay. But governments will also need to spend more – on the poor (although cross-subsidies can help) and on sectors with limited cost recovery potential.
- **It also needs to spend better.** A better allocation of resources is needed between investment and maintenance. New investments must be focused on increasing productivity and competitiveness – which need not come at the expense of social goals: universal coverage of water, sanitation and electricity could be achieved over ten years by spending less than a quarter percentage point of GDP per annum. Subsidies must be better targeted to benefit those who need them. And better concession design will ensure that governments do not take on more risk than necessary and are not saddled with large contingent liabilities.
- **Governments remain at the heart of infrastructure service delivery.** Private participation does not reduce the need for public involvement. Governments still need to regulate infrastructure provision as well as paying for a good share of investments. They must leverage their resources to attract as much complementary financing as possible. And they are still responsible for setting distributional objectives and ensuring that resources and policies are available to permit access for the poor.
- **The private sector is needed, but bringing it back requires building on the lessons of the last decade.** Private transactions have collapsed to less than a quarter of their peak level and show no immediate sign of recovering, given investors' disaffection with emerging markets. Bringing back the private sector will require improving the risk-return ratio for projects. This entails decreasing

regulatory risks and improving the framework for private participation in infrastructure (PPI) as well as developing risk mitigation mechanisms. It also means improving public perceptions of PPI, which are so overwhelmingly negative in some countries as to be a serious constraint on further PPI. This, in turn, requires greater transparency, improved transaction design and oversight to reduce renegotiations and poor performance, and better management of those that stand to lose.

Organization of the report

The first section of the main report reviews progress made in infrastructure coverage and quality and discusses the impacts this has had on growth, competitiveness and the fight against poverty. The second section argues that the main issue has been that there has not been enough improvement in the management of resources, which have been insufficient anyway, and also reviews the region's experiences with PPI. The third section builds on the lessons of the last decade to tackle the key challenges: improving social and economic returns from infrastructure, managing PPI better and raising new finance for infrastructure. The rest of this overview provides a quick summary of the report.

Sins of omission

This report does not cover two critical sectors that should arguably be included in any discussion of infrastructure. The first is housing (which is infrastructure in its own right, but also provides the “shell” through which the much of the impact of water, sanitation, and electricity is felt. Indeed, housing is a critical component of any economy, accounting for the vast majority of people's investments and wealth. Its exclusion from the report is not due to an under-estimation of its importance, but rather to the fact that it draws upon different skills and literature. The same can be said for hydrocarbons, which are critical to a number of countries of the region.

It is difficult in a report of this kind to do justice to the tremendous diversity of the region – countries vary from Caribbean islands with less than 100,000 inhabitants to Brazil with close to 180 million people; from Haiti with an income per capita of US\$467 to Mexico with more than \$6,000. It is our belief, however, that the key messages of this report apply to all countries, regardless of size and income, although the best ways to implement the recommendations may vary. For example, small countries may need to pursue cross-country initiatives more than large ones (as in the Caribbean's ECTEL agency for telecom which is the world's first cross country regulatory decision-making body).

Infrastructure in LAC over the last decade – improvements have been too modest

Coverage and quality of infrastructure have increased in most sectors and countries of Latin America and the Caribbean over the last decade. There have been major improvements in access to water and sanitation, electricity, telecommunications, ports and airports. Road transport is the only sector in which coverage has not changed much.

However, the region has lost ground relative to competitors and peers. In 1980, LAC had higher coverage of productive infrastructure such as roads, electricity and telecommunications than the countries that subsequently became known as the East Asian Tigers. Today, the Tigers lead by a factor of three to two. LAC also trails behind the middle income average as well as China, even though the region is richer in per capita terms. The only sectors in which the region has done

comparatively well (at least in terms of coverage) are water and sanitation.¹ But even there, there is no room for complacency: 58 million Latin Americans lack access to potable water and 137 million have no adequate sanitation.

Figure 1: Latin America has lost ground against the East Asian Tigers, China and Middle Income Countries

(a) Infrastructure index, LAC vs. Tigers

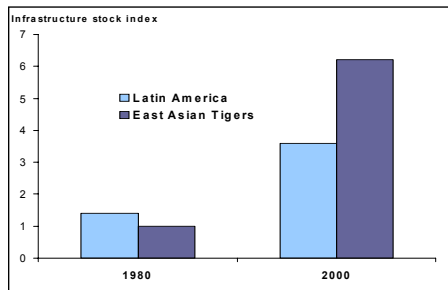

(b) Infrastructure stocks, LAC vs. China and MICS

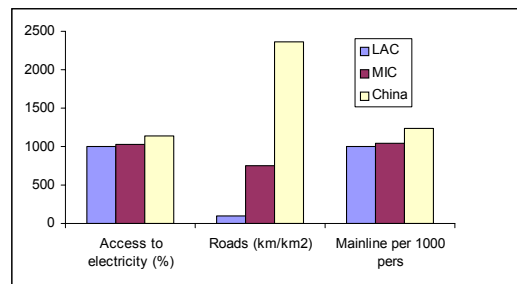

Note: Infrastructure stock index includes paved roads, electricity generating capacity and telephones (main lines and mobile) per worker. The index is calibrated so that East Asian Tigers had a value of 1 in 1980. Source: Calderón and Servén 2004; World Development Indicators.

This is hampering economic growth and the fight against poverty. Studies suggest that the growth impact is large: for example, improving the region’s infrastructure to the level of Korea (the East Asian Tigers median) could result in annual per capita GDP growth gains of 1.4 to 1.8% of GDP. It could also reduce inequality by 10% to 20%, thereby helping make growth more pro-poor (Calderón and Servén 2004). The investment required would, however, be substantial: at least 4 - 6% of GDP per year over 20 years. At the micro level, the poor quality of infrastructure is affecting the competitiveness of businesses – indeed, while 55% of private sector entrepreneurs complain that infrastructure is a serious problem in Latin America, only 18% do in East Asia.

Private entry could not offset public retrenchment

Two major developments have shaped infrastructure trends in the last fifteen years. First, many Latin American countries experienced traumatic macro-economic crises that required drastic fiscal adjustments. Second, technical, financial and regulatory innovations led to a sea-change in the infrastructure paradigm, with the notion that the private sector would become central in both the financing and provision of infrastructure while the role of governments would be mostly limited to a regulatory one.

In most Latin American countries, public investment, particularly in infrastructure bore the brunt of fiscal adjustment. Regionally, public investments in infrastructure fell from more than 3% of GDP in 1988 to about 1.6% in 1998 (Figure 2). Politically, these were much easier to cut than current expenditures such as salaries and pensions. Brazil, the most extreme case, actually increased current expenditures while cutting investments, especially in infrastructure.

¹ No readily available, systematic data exists for comparison in terms of ports, airports and urban transport infrastructure.

Figure 2: Primary deficit and public infrastructure investment (% of GDP)

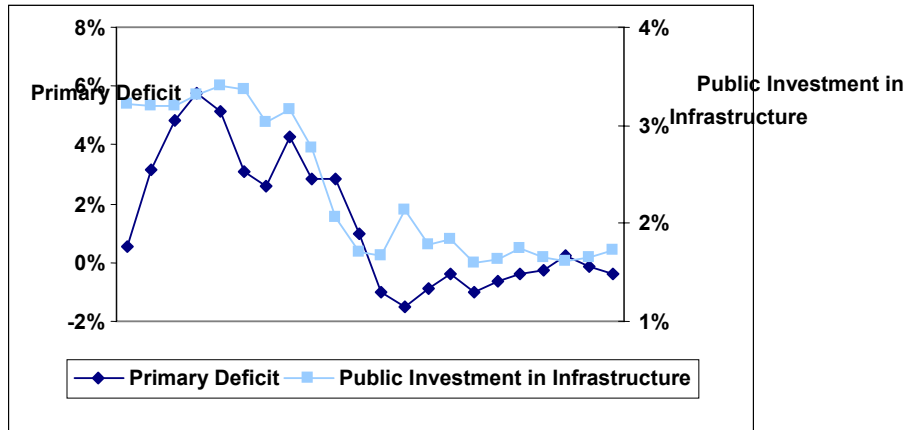

Source: Servén, 2005. Note: average of Argentina, Bolivia, Brazil, Chile, Colombia, Costa Rica, Mexico and Peru.

However, Latin America did spectacularly well in attracting PPI. It was the beneficiary of half of the \$786 billion in infrastructure projects with private participation in the developing world between 1990 and 2003. And PPI did transform infrastructure provision. At the start of 1990, only 3% of telephone and electricity connections in the region were provided by private companies, and almost no water utilities were in private hands. By 2003, private utilities were managing 86% of telecom subscriptions and 60% and 11% of electricity and water connections respectively (Andres, Foster and Guasch 2005).

Still, private flows were never enough to offset the massive collapse in public investment (although they came close in aggregate: at the peak, in 1998, investments projects with PPI amounted to 1.7% of the region’s GDP). In addition, private interest was focused on a limited number of countries (six of them attracted 93% of all flows) and sectors (telecommunications absorbed nearly half of regional PPI).

Figure 3: Privatization has become very unpopular in Latin America

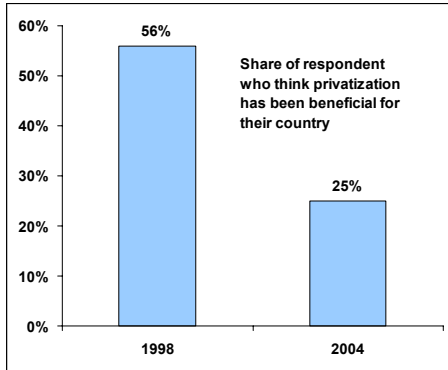

Source: Latinobarometro surveys, 1998-2002

Today, public opinion in the region has turned against PPI to the extent that it has become a serious constraint in many countries (Figure 3). And private investors’ appetite for both emerging markets and infrastructure has waned. Investments with private participation have now collapsed from about US\$71 billion in 1998 to US\$16 billion in 2003. A further illustration is

given by the decline in the average number of bidders on power distribution transactions from four in 1998 to less than two in 2000 and 2001 (Harris 2003).

But the public reaction is at odds with the generally positive evaluation of the impact of privatization: in most cases, efficiency has improved, and coverage and quality increased. Labor productivity has also generally improved, although this is largely due to substantial layoffs. But most studies suggest that the layoffs were small relative to the overall workforce and that they were reversed as employment grew in the medium run. Most of these effects (increases in prices and efficiency, as well as layoffs) took place in the transition to privatization with changes in the five years prior to privatization, generally much greater than in the five years that followed (Andres, Foster and Guasch 2005). The impact on the poor has also generally been good, mostly because they have often been the primary beneficiaries of increases in coverage.

Contrary to perception, concessionaires do not appear to have made excessive profits. The picture that emerges is that concessions are a risky business, and that about 40% of concessions may never turn a profit, at least on their original terms (Sirtaine et al. 2005). Only in telecommunications do concessions appear almost always profitable. These results need to be treated with caution however, as they rely on estimates of the cost of capital (which are imprecise), and actual outcomes are affected by concessionaires' ability to renegotiate. Nevertheless, the reduced appetite of the private sector for PPI in LAC does testify to the absence of extraordinary returns.

Popular rejection of the PPI model may largely be due to poorly managed perceptions, as well as unreasonable expectations. In addition, several researchers have argued that macro-economic crises lead to blanket rejections of the market economy model and that people do not distinguish job losses due to recessions from those due to privatization. More generally, the perceived transparency and fairness of a transaction is crucial in shaping public perception.

The reaction to PPI may also be due to excessive renegotiations and a few well publicized failures. Guasch (2004) finds that 30% of the region's concessions were re-negotiated, with the incidence rising to a staggering 74% in the water and sanitation sector. Whatever the motivation (opportunistic behavior on the part of governments or concessionaires, poorly designed contracts or exogenous shocks) frequent renegotiations are costly, disruptive, anticompetitive, and lead to a perception of lack of transparency.

Many of the difficulties that have occurred with PPI are due to immature regulatory frameworks and institutions. Introducing PPI required sweeping changes in the region's regulatory, legal and institutional frameworks, which often were not fully functional by the time privatization came about. In addition, with the benefit of hindsight it is quite clear that analysts and reformers were overly optimistic as to the ability of reforms and regulation to isolate transactions from political influence – and as to the appropriateness for Latin America of models developed for mature infrastructure networks in industrialized countries.

In addition, cost recovery proved elusive. Even though it appears to have improved in water and sanitation as well as in electricity, it has only been fully reached (in most cases) for telecoms. Yet studies suggest that affordability is a problem only for a small minority of the population, with the exception of the poorest countries in the region. And in many cases, governments are unwilling or unable to enforce service payments – a common complaint of concessionaires.

Poorly targeted social tariffs hinder cost recovery and do too little for the poor. In most countries, social tariffs for water and electricity benefit far too many of the non-poor: 95% of Guatemalans

and 85% of Hondurans benefit from the social tariff in electricity. The result is a continued dependence on public transfers. In Mexico, for example, low electricity tariffs set by the Ministry of Finance result in the need for a public subsidy amounting to close to 1% of GDP.

Having laid out this background, we now turn to the key challenges that Latin America needs to address. These are organized around the four key messages of this report.

Message 1: Latin America needs to spend more on infrastructure

How much is needed for infrastructure investments depends, of course, on the goal set. Universal coverage for water and sanitation and electricity could be achieved over ten years at the relatively modest cost of about 0.25% of GDP. Adequate maintenance of existing assets in WSS, electricity, roads, rail and telecom would require about 1% of regional GDP. A “business as usual” approach suggests that a further 1.3% of GDP would be needed in new investments to satisfy consumer and firm demand based on modest growth assumptions. (See Annex II on investment needs for details).

Pulling these estimates together, the implication is that about 2.5% of GDP would be enough to respond to expected growth in demand from firms and individuals, maintain existing infrastructure and achieve universal coverage in WSS and electricity. This is a lower bound estimate as it does not include the cost of rehabilitation (which is likely to be large) or needed investments in urban transport, ports and airport.

But a much higher amount (4% to 6%) of GDP would be required to bring LAC to Korea’s level of coverage over 20 years or simply to keep up with China. Clearly spending on infrastructure alone will not be sufficient to guarantee for LAC the kind of growth that these countries have been experiencing in recent decades. And strong growth obviously generates more demand for infrastructure, and money to pay for investment. Nevertheless, it is clear that a failure to keep up with other countries’ infrastructure can only harm the region’s competitiveness. Adding maintenance, a growth and competitiveness-enhancing scenario would require annual expenditures of 5% to 7% of GDP. While ambitious, this is not unrealistic. Similar increases were in fact achieved by Korea (as well as China, Indonesia, and Malaysia) over the 20-year period from the late 1970s to the late 1990s.

This could not be funded by the public sector alone (or would require a massive reallocation of resources): public expenditures amounted to an average of about 22% of GDP in the region in 2000-2001, with total public investments around 3% of GDP. But investments with PPI only currently amount to only about 0.9% of regional GDP, and most of this is in energy and telecoms.²

The implication is that governments need to better leverage their resources to promote PPI. And also that greater cost recovery is needed – there is only so much the taxpayer can or should fund. Cost recovery has largely been achieved in the telecommunication sector and is technically not achievable in roads except for a tiny fraction of the network, so not much change can be expected in these two sectors.³ On the other hand, there is room to increase cost recovery in water and

² Of the 0.9% of GDP, 0.43 went to the energy sector, 0.41 to telecom, 0.05 to transport and 0.01 to WSS.

³ Toll roads require a minimum amount of traffic to be commercially viable. As a result, even in industrialized countries, toll roads only account for 5% to 10% of the primary network, which itself

sanitation and electricity (even though cost recovery in these sectors is already higher in LAC than in any other developing region and has actually improved over time), and probably in ports and urban transport.

Higher tariffs are a reasonable policy goal only if they are affordable. But simulations show that affordability is a problem only for a small share of the population in LAC, with the exception of some of the poorer countries in the region (Bolivia, Honduras, Nicaragua, and Paraguay) where a utility bill of \$10 a month is already a substantial burden for 30% to 50% of urban households. Government commitment and backing is critical for greater cost recovery (indeed many private operators complain of a lack of support and enforcement in cost recovery) as is improved subsidy targeting.

Message 2: Latin America needs to spend better

Better subsidy targeting would go a very long way in both freeing up resources for investment and maintenance, and making tariff increases socially feasible. Modifying existing tariff structures (for example by reducing the size of the subsidized block of increasing block tariffs) would help reduce the overall cost. The impact on targeting may be positive for electricity where there is a relationship between quantity consumed and income, but much less so in water where the relationship between consumption and income is more tenuous. In countries that already have means-based social assistance, existing databases can be used to identify the poor and their needs. In countries that do not, geographic targeting is an option, although one that can exclude deserving households while including too many non-poor ones. But restructuring or abandoning consumption subsidies can be politically difficult. Eleven years after the passage of a public services law in Colombia that required base utility tariffs to rise to cost recovery levels, the water sector continues to make substantial fiscal demands.

Better expenditure allocation is also needed. In particular, not enough is being spent on maintenance. Many countries lack a reliable source of funding to ensure the regular maintenance needed, notably in roads which are mostly publicly funded and hence subject to the vagaries of the fiscal situation. New investments should aim to focus on strategic goals, such as completing networks. But tackling bottlenecks should not come at the expense of providing service to the poor, which, as mentioned earlier, can be done at a relatively low cost. Decentralization and participatory planning can help – although they can also complicate matters.

Expenditures can also be made more efficient in a number of ways. More reliable expenditure flows would substantially reduce the overall cost of investment programs as well as allowing for regular maintenance programs. In Brazil's road sector for example, disruption in payments to contractors occurs regularly, due to budgetary shortfalls, and are sometimes used by contractors to invoke price escalation clauses. Similarly, Governments tend to pay much more for goods and services than the private sector, due to collusion among vendors and other factors. An effective procurement (or competition) agency can significantly reduce total costs. For small countries, a case can be made for regional procurement agencies.

Finally, a better PPI framework can help reduce the cost of attracting private resources and improve the benefits of PPI. Regulatory risk bids up the cost of capital by 2% to 6% (Guasch and

represents only about 10% to 20% of the overall network (Heggie and Vickers 1998). Toll roads in the US, for example, represent 0.08% of all paved roads

Spiller 2004). Andres, Guasch and Foster (2004) find that improvements in quality and efficiency of services brought about by privatization are much greater when the concession was awarded competitively and the autonomy of the regulator was greater.

The award criteria and regulatory regime matter as they affect the incentives facing concessionaires. Price cap regulation, for example, has been very common in Latin America and has been found to have the highest impact on efficiency improvements. However, it is riskier for the concessionaire (because it does not guarantee profits), thereby increasing the cost of capital and is much more prone to renegotiation than other regimes. And renegotiations are costly – financially, in terms of disrupted services, and through their impact on the credibility of the PPI model.

Concretely, a better PPI framework entails improving award processes to ensure transparency and competitiveness. It also requires better concession design to clearly state events that would trigger renegotiations, as well as guidelines for the process. Contracts also need to specify information to be disclosed. This, combined with an adequate regulatory accounting framework, is critical for regulators to cope with the asymmetry of information inherent in any concession. Finally, lessons have been learnt on the relative desirability of particular regulatory regimes.

In addition, risks can be managed and allocated better. Contracts, in particular, should better identify and allocate the different risks involved. Governments need to focus on improving the risk-return ratio of investment projects, but must be careful which risks they assume. Many face enormous contingent liabilities from such excessive commitments made in the past.

Third-party guarantees are increasingly necessary. Infrastructure concessions often use project financing, which may require risk protection instruments (particularly against regulatory and exchange rate risk) to make the risk-return ratio attractive to outside investors in such projects. But when the government accepts such risks through guarantees or other structures, lenders and investors become exposed to its sovereign risk and the credit rating this implies. This may be unacceptable to international and even local investors, who may be heavily exposed to sovereign risk already, as is the case with many Latin American pension funds and insurance companies as these often invest mostly in government securities.

A critical remaining difficulty concerns institutional reform. While many of the technical improvements discussed earlier are fairly straightforward, their implementation depends on having the right institutions and capacity in place – a much more difficult undertaking. It may be unproductive to require a comprehensive set of functional institutions as a prerequisite for private participation in infrastructure projects. Institutional advances in infrastructure will unfold at a pace that depends on the political economy of reform, the cultural context, and the country-specific ways of securing property rights.

Message 3: Governments remain at the heart of the infrastructure challenge

With or without private sector participation, governments remain responsible for sector reform and regulation. This includes the management of the political economy of reform. Infrastructure reforms are political processes, prone to backlash. Reform “losers” may aim to recover the benefits they enjoyed in the past, while reform “winners” may not feel like they have really benefited, as they perceive either that current sacrifice will not be rewarded with future gains, or that private firms will eventually capture most of the gains. To push reforms forward, governments and regulators need to find ways to take the reforms out of “redistribution traps”, in

which the gains of one group become (or are perceived as) the losses of another. If those who stand to lose have veto power, the reforms will not consolidate.

Governments also remain responsible for social goals. Again, with or without PPI, the design, monitoring and funding of social policies are public responsibilities (although cross-subsidies can help pay for them, notably in water and electricity). But the private sector can be tapped, for example through output-based aid. And small scale providers can offer low cost solutions for to service to the poor. Social tariffs are not only critical for social reasons; they are also critical to the success of any reform.

Governments are responsible for much of infrastructure finance, both directly and indirectly, by helping structure financing frameworks. A critical issue is how to generate the fiscal space for increased public investments. A number of countries are saddled with a large debt burden. Many (Brazil, Colombia and Peru, for example) suffer from expenditure rigidities, as more than 90% of the budget is non-discretionary (pensions, social security, debt service, wages, transfers to sub-national governments). Some have scope for increasing tax collection (Honduras) while others do not. In fact, in the case of Brazil, where the tax-to-GDP ratio has reached 35%, simulations suggest that the impact of a further tax increase would more than offset the growth and welfare benefits of increased infrastructure investments (Cavalcanti and Nascimento 2005).

Several options have been suggested to increase fiscal space, based on the argument that current rules only reinforce the tendency of politicians to cut investments rather than more politically sensitive current expenditures. One approach could be to adopt alternative rules, such as the so-called golden rule that permit borrowing to finance capital but not current expenditures. Another could be to exempt particular investments based on their social or economic rates of return. The first option has been rejected by the IMF, while implementation of the second is unlikely to allow for significant fiscal space to open. The way forward will probably have to be determined on an ad hoc basis by countries through a combination of expenditure reallocation, improved expenditure efficiency and reliance on increased revenues associated with better growth performance.

Governments can also help in providing a financing framework for long-duration infrastructure investments. For example, investors are likely to favor projects in which substantial local currency financing can be incorporated. This can be done either by developing local capital or debt markets or through local currency loans, hedging products or creative financing structures offered by private, bilateral or multilateral financing institutions. Partial Risk Guarantees (PRGs) from multilateral institutions can protect lenders or bond holders against other perceived risks, providing the credit enhancements that project companies require to raise adequate financing. Governments have a critical role to play in establishing wholesale facilities for these instruments, such as the recent World Bank PRG facility established in Peru.

Finally, sub-national entities need to be able to borrow to fund the infrastructure they are responsible for. This of course needs to be done in the context of a prudent inter-governmental framework and in many countries requires substantial reforms. In the shorter term, multilateral institutions, such as the World Bank, have various instruments allowing countries to borrow and on-lend in local currency to sub-nationals.

Message 4: The private sector is needed, but bringing it back will require learning from the past

The private sector is critical, for financial resources as well as the know-how and management skills needed for better infrastructure performance. An improved PPI framework, concession design and risk management instruments are important factors in attracting back the private sector. Another element is better management of the political economy of reform. Indeed, winning back public opinion is probably one of the most pressing challenges of PPI in the region today.

Improving the perception of PPI will require a number of steps. Concessions need to be granted in a transparent manner. Re-negotiations need to be less frequent. And finally, governments need to shoulder their responsibilities - on painful reforms, on appropriate safety nets for those who stand to lose from the reform process, and for the poor.

Facing the Challenges: Setting Priorities

In the 1990s the emphasis was on the fight against poverty, which was equated rather narrowly with a need to increase social services. This culminated with the Millennium Development Goals that focus on reducing poverty and improving health and education outcomes. Indeed today Latin American countries spend about 8% of GDP on health and education expenditures (quite a bit more than East Asia, middle income countries or China) and a similar amount on social security and welfare.⁴ As for infrastructure, the thinking was that the private sector could finance much of what was needed as a combination of efficiency gains and greater cost recovery could ultimately generate sufficient returns.

Today the pendulum has swung somewhat. The World Bank's recent Annual Review of Development Effectiveness produced by its internal evaluation department calls for a renewed focus on infrastructure. It argues that more attention should be paid to the growth agenda and that just focusing on the social sectors is not enough for poverty reduction. Similarly, the IMF's Independent Evaluation Office has argued that more attention should be paid to the quality of fiscal adjustment, and that fiscal consolidation came at the expense of public investment. And the private sector is less enthusiastic about infrastructure projects— especially in emerging markets – while Latin America's people massively reject the privatization model.

This report does not argue that governments need to slash social expenditures in favor of infrastructure but rather that they should consider all the considerable potential returns on infrastructure investment - not just financial, but economic and social –when setting budgets. This is not based on a simplistic view that by narrowing the infrastructure gap between East Asia and Latin America, the region will be transformed into a collection of “tigers.” Common sense, as well as solid empirical evidence, shows that infrastructure is necessary for growth and poverty alleviation - necessary, but clearly not sufficient. And the returns to infrastructure projects vary with the level of infrastructure already in place, and with the quality and efficiency of the individual projects, just as for any other investment.

The financial and human resources available for improving infrastructure will still be limited. How then to set priorities among all the competing needs for investments or reform? Our

⁴ Note that health and education expenditures tend to increase with income and LAC is richer than these other groups.

suggestion, for the short term, is to go for the low hanging fruits, meaning the interventions that are not too costly financially or difficult politically. On the publicly managed infrastructure side, this includes improving procurement, stability of financial flows for public investment and maintenance, and better maintenance programs. On the PPI side, it means not guaranteeing inappropriately, developing better financial products (particularly ones that tap local financial markets) and applying what has been learnt about the better design of contracts.

As for investments, one key argument of this report is that LAC can afford universal coverage in water, sanitation and electricity, if appropriate technologies and standards are used. In addition, the context of scarce resources implies that investments need to focus on bottlenecks in existing systems rather than on overall expansion.

INFRASTRUCTURE IN LAC – SOME PROGRESS, BUT NOT ENOUGH

Coverage and quality have improved for most infrastructure services in recent decades but gaps remain and ground has been lost relative to competitors. Progress has been steady if uneven across sectors and countries, as well as within countries, with rural areas lagging behind in terms of coverage. Major coverage gaps persist among the poor (both rural and urban), who also tend to suffer disproportionately when quality of service is poor. And progress has not kept up with competitors: middle income countries, East Asian “miracle” economies and China.

This dampens the region’s growth and competitiveness and hampers the fight against poverty alleviation, exclusion and inequality. Recent analysis in Colombia shows that infrastructure services account for about 16% of production costs overall. While similar estimates are not available for LAC as a whole, it is clear that better infrastructure will have huge impacts on competitiveness, as well as on growth. Infrastructure is also essential in helping the poor improve their health, quality of life and ability to engage in productive activities. As a result improved infrastructure has been found to significantly contribute to reduced inequality (Calderón and Servén 2004b).

Coverage and quality have improved, but slowly

Coverage levels for most infrastructure services have improved steadily in Latin America and the Caribbean (LAC) over the last two decades. Since 1985, most countries in the region have made considerable progress in expanding access to fixed telephone lines, electricity, safe water and improved sanitation facilities. The last ten years have seen an explosion in the use of cellular telephones and the internet. Electricity generation capacity has also grown. In the transport sector, while road coverage has not changed substantially, numerous port concessions have led to substantial modernization. Only in roads has there been little change in terms of coverage. As to rail, it has actually shrunk as a number of rail companies were privatized and loss making routes closed. (Annex 1 has more details on the sectoral evolution of coverage).

However, progress has generally been slower than in other middle income countries, notably China. LAC has now fallen behind China as well as the middle income country average for major categories of productive infrastructure (electricity, roads and telephones) (table 1). Only in cellular telephony and access to safe water and improved sanitation facilities has Latin America performed comparatively well, particularly during the 1990s. This is particularly notable as Latin America as a region is wealthier than the middle income average and still substantially richer than China in per capita terms.

Table 1: Infrastructure coverage in LAC, China and middle income countries

	Access to electricity (%)	Roads (km/km2)	Mainlines per 1000 people	Cellular telephones	Water (%)	Sanitation (%)
LAC	87	0.008	170	246	89	74
China	99	0.189	209	215	77	44
MIC	90	0.06	178	225	83	61
<i>Year</i>	<i>2000</i>	<i>2002</i>	<i>2003</i>	<i>2003</i>	<i>2002</i>	<i>2002</i>

Source: World Development Indicators. Note that low road density in LAC is largely explained by much lower population density (26 persons/km2 vs. 43 in MICs and 137 in China) – the road density is much

lower in LAC regardless of the deflator used (population, area, GDP or any combination thereof) and whether we use total roads or paved roads. See Appendix Table 1 in Volume II for details. GDP per capita (in 2000 US\$) is \$983 for China, \$1876 for middle income countries and \$3759 for LAC.

The infrastructure gap with the seven East Asian “tigers” has widened.⁵ The gap –the change in Asian infrastructure stocks per worker relative to Latin America’s– grew by a huge margin over 1980-1997. Comparing simple averages for each region, the advantage of the East Asian tiger economies grew by 48% for fixed phone lines, 91% for power-generating capacity, and 53% for road length (Calderón and Servén 2003).

Quality has generally improved, but also lags behind competitors. Quality data is thinner, but generally follows the same improving trend as coverage. In the power sector, privatization of the distribution segment resulted in a reduction in distributional losses for electricity distribution from 16.7% in the three years prior to the change in ownership to 14.5% in the three years following privatization (Andres, Guasch and Foster 2005). This remains high compared to middle income countries (12%), China (7%) and the OECD (6%) although part of the difference may be due to differences in system design. Overall, a recent study of seven Latin American countries found that public infrastructure in the region (including privately owned public services) is only about 74% as effective as that of industrial countries because of poor quality (Rioja 2003). And survey data (discussed in depth below) shows that businesses consider infrastructure quality in LAC to be a problem.

Behind regional averages, performance varies greatly among countries. Some infrastructure sectors, particularly in the wealthier countries of the region, compare in quality and coverage to OECD levels while others are closer to Africa’s. Less than a quarter of national roads are officially deemed in good condition in Brazil, Peru, Mexico and Nicaragua, while 80% are in Argentina. In Costa Rica, 98% of households have an electricity connection, while in Peru only 69% do. Uruguay has sixteen times more fixed telephone lines per capita than Haiti. Coverage patterns reflect not only the huge differences in income between countries but also the region’s great geographical diversity. In the small densely populated island states of the Caribbean, road coverage levels tend to be higher than in larger, more geographically challenging countries.

There is also a sharp divide between rural and urban coverage within countries. For water, electricity, roads and telecommunications, coverage rates in rural areas tend to be much lower. While more than 90% of the urban population of most countries in the region have access to safe water, rural access in Brazil (58%) and Chile (59%) is worse than in several much poorer African nations such as Burundi (78%) and Zimbabwe (74%).⁶ And in Colombia, one third of the rural population does not have ready access to the road network, and the average rural household lives 2.5 kilometers from an all-season road (World Bank 2004b). Given that poverty rates are usually much higher in the countryside, lower rural access rates explain much, though by no means all of the great disparity in coverage between the rich and poor in Latin America.

Urban coverage is usually extensive for most services, but rapid growth of cities has put pressure on infrastructure, and access and quality are often inadequate in poor

⁵ Tigers include: Hong Kong (China), Indonesia, Republic of Korea, Malaysia, Taiwan (China), Thailand and Singapore

⁶ Data is for 2002 and is from the World Bank World Development Indicators Database, using WHO and UNICEF data.

neighborhoods. LAC is the most urbanized developing region, with around 77% of its people living in cities and towns, up from 68% in 1985. The rapid expansion of many cities in recent years has strained existing infrastructure, particularly in the peri-urban areas where many migrants end up. While urban poverty rates tend to be much lower than rural ones, about half the region’s poor (or around 113 million people, on World Bank estimates) live in urban areas, many of them in recently or informally settled areas that may lack basic services. Telephone access (including cellular) and sewerage and drainage tend to be the most unequally distributed services within cities (World Bank 2004c.)

Infrastructure provision tends to reflect and reinforce the region’s existing poverty profile and extreme income inequality. Coverage levels are usually much higher for the fifth (i.e. richest) quintile, particularly in rural areas, as Table 2 shows for piped water connections. Only 3% of the poorest fifth of rural Paraguayans had these, against 32% of the richest quintile. And while overall urban coverage levels tend to be higher, aggregates can hide dismal coverage levels among the urban poor. Of this group only 35% had piped water in urban El Salvador, against 87% of the richest fifth.

Table 2: Piped water connections, by expenditure quintiles

	Year	Urban - by quintile (percentage)					Rural - by quintiles (percentage)				
		1	2	3	4	5	1	2	3	4	5
Bolivia	1999	76	84	87	93	97	17	25	27	36	50
Brazil	1996/7	63	85	90	97	98	7	30	42	48	37
Chile	1998	97	98	99	99	100	30	39	41	42	40
Colombia	1997	92	97	98	98	99	50	54	58	63	70
Ecuador	1998	52	64	70	73	92	40	42	45	57	47
El Salvador	1998	35	52	66	75	87	19	27	30	41	35
Nicaragua	1998	57	75	83	89	93	13	32	42	44	53
Paraguay	1997/8	30	50	61	72	83	3	13	20	26	32

Source: PAHO (2001)

Slow infrastructure gains imply reduced growth and competitiveness

Infrastructure is critical to an economy’s functioning. There is now a broad consensus among researchers around this common sense finding: an exhaustive survey of the literature by Calderón and Servén (forthcoming 2005) covering 62 papers confirms that studies that fail to cover a positive impact of infrastructure on output or a negative one on production costs have become very rare. Further, those that do cover developed, rather than developing, countries. This is consistent with another survey of 102 papers discussed in Briceño-Garmendia, Estache and Shafik (2004). Note however that the extent to which infrastructure investments translate into productive assets varies across countries with procurement efficiency, corruption, or even project selection capacity. As such, we do not expect to find a similarly robust relationship between (public) investment and growth.

Rates of return to infrastructure depend on the existing level of assets as well as their quality. As a result, the productivity of infrastructure is usually found to be higher among low and middle income countries, and decreases among high income countries (Box 1). Rates of return vary across countries and sectors but are mostly “normal”. Indeed, estimated of social

rates of return from cost-benefit analysis of World Bank projects in Latin America vary from 11% to 22% depending on the sector (Briceño-Garmendia, Estache and Shafik 2004).

Infrastructure has a significant impact on growth in Latin America, both statistically and economically. Empirical analysis by Calderón and Servén (2003) finds a positive and significant contribution of infrastructure to output levels and growth in Latin America. In fact, the estimated marginal productivity of telecommunications, transport and power significantly exceeds that of non-infrastructure capital. Calderón and Servén also find that the region's slow infrastructure accumulation in the 1980s and 1990s relative to East Asia explains much of why it has also lagged behind economically: the differing evolution of infrastructure assets in Latin America and East Asia widened the cross-regional gap in GDP by some 30% over 1980-97.

Box 1: Infrastructure, productivity and growth: what the literature says

A number of studies have found empirical support for a positive impact of infrastructure on aggregate output, especially in developing countries. Overall, results suggest that the returns to infrastructure investment are probably highest during the early stages of development, when infrastructure is scarce and basic networks have not been completed. Returns on infrastructure investment tend to fall, sometimes sharply, as economies reach maturity, so that some studies of the U.S. have even found negative effects.(Briceño- Garmendia, Estache, Shafik 2004).

In a seminal paper, Aschauer (1989) found that the stock of public infrastructure capital is a significant determinant of aggregate TFP. However, the economic significance of his results was deemed implausibly large, and found not to be robust to the use of more sophisticated econometric techniques (Holtz-Eakin, 1994; Cashin, 1995; Baltagi and Pinnoi, 1995). Gramlich (1994) provides an overview of this literature.

A more recent empirical literature, mostly in a cross-country panel data context, has confirmed the significant output contribution of infrastructure. It relies on increasingly sophisticated econometric techniques to address reverse causation (infrastructure may cause growth, but growth also causes firms and people to demand more infrastructure - failure to take this into account would result in the over-estimation of the contribution of infrastructure to growth).

Notable papers include Canning (1999) using panel data for a large number of countries and by Demetriades and Mamuneas (2000) using OECD data. Roller and Waverman (2001) also find large output effects of telecommunications infrastructure in industrial countries, in a framework that controls for the possible endogeneity of infrastructure accumulation. Similar results for roads are reported by Fernald (1999) using industry data for the U.S. Calderón and Servén (2003), present a similar empirical analysis with a focus on Latin America. They find positive and significant output contributions of three types of infrastructure assets – telecommunications, transport and power.

A few papers go beyond measures of infrastructure spending and infrastructure stocks and consider the issue of infrastructure efficiency or quality. Hulten (1996) finds that differences in the effective use of infrastructure resources explain one-quarter of the growth differential between Africa and East Asia, and more than 40 percent of the growth differential between low- and high-growth countries. Esfahani and Ramirez (2002) report significant growth effects of infrastructure in a large panel data set in which the contribution of infrastructure is affected by institutional factors. Finally, Calderón and Servén (2004b) find a robust impact of both infrastructure quantity and quality on economic growth and income distribution using a large panel data set encompassing over 100 countries and spanning the years 1960-2000. They use a variety of specification tests to ensure these results capture the causal impact of the exogenous component of infrastructure quantity and quality on growth and inequality.

Source: Adapted from Calderón and Servén (2004b) with input from Briceño-Garmendia, Estache, Shafik (2004)

Improving the level and quality of infrastructure could have considerable growth payoffs.

The work of Calderón and Servén (2004b) allows for an interesting thought experiment on the growth payoffs of raising infrastructure stocks and quality (Table 3). Based on their estimates, if all Latin American countries were to catch up with Costa Rica, the region's leader in terms of infrastructure quantity and quality, their long-term per capita growth gains would range between 1.4 and 1.8% per annum. Catching up with the East Asian median country, Korea, would entail even larger gains.

The investment needed would be large, but not impossibly so. LAC would need to invest 4% to 6% of GDP every year for 20 years to reach Korea's level of productive infrastructure.⁷ While ambitious, this is not unrealistic.⁸ Similar increases were in fact achieved by Korea (as well as China, Indonesia, and Malaysia) over the 20 year period from the late 1970s to the late 1990s. Indeed, Korea's infrastructure endowments 25 years ago were substantially worse than Mexico's, Argentina's or Brazil's at the time. And if Calderón and Servén are right, the payoffs in terms of growth and decreased inequality would be substantial.

Table 3: Potential growth improvement in LAC countries due to infrastructure development

<i>Country</i>	<i>Improvement to levels of LAC leader</i>			<i>Improvement to levels of East Asian tigers median</i>		
	<i>Stocks</i>	<i>Quality</i>	<i>Total</i>	<i>Stocks</i>	<i>Quality</i>	<i>Total</i>
Argentina	1.3%	0.4%	1.7%	2.2%	0.9%	3.2%
Bolivia	3.8%	0.5%	4.3%	4.8%	1.0%	5.8%
Brazil	1.5%	1.4%	2.9%	2.4%	1.9%	4.4%
Chile	1.3%	0.0%	1.3%	2.3%	0.6%	2.8%
Colombia	1.9%	1.2%	3.1%	2.9%	1.7%	4.6%
Costa Rica	-	-	-	1.0%	0.5%	1.5%
Dominican Rep.	1.3%	0.1%	1.4%	2.3%	0.7%	2.9%
Ecuador	2.0%	1.0%	3.0%	3.0%	1.5%	4.5%
Guatemala	3.3%	0.4%	3.7%	4.2%	0.9%	5.2%
Honduras	3.1%	1.1%	4.2%	4.1%	1.6%	5.7%
Mexico	1.4%	0.2%	1.7%	2.4%	0.8%	3.2%
Nicaragua	3.4%	1.4%	4.8%	4.4%	1.9%	6.3%
Panama	1.4%	0.2%	1.5%	2.4%	0.7%	3.1%
Peru	3.0%	0.6%	3.5%	4.0%	1.1%	5.0%
El Salvador	1.6%	0.4%	2.1%	2.6%	1.0%	3.6%
Uruguay	0.7%	0.4%	1.1%	1.7%	0.9%	2.6%
Venezuela	1.1%	0.4%	1.4%	2.0%	0.9%	2.9%

Source: Calderón and Servén (2004)

Infrastructure is an important determinant of productivity. Infrastructure in developing countries is used in approximately equal shares by households as a final consumption item and by firms as an intermediate consumption item (Prud'homme 2004). The availability and quality of

⁷ This assumes a 2.7% per annum GDP growth, 1.24% per annum population growth and an alternative goal of one third the road density of Korea. Infrastructure includes telephone (fixed and cellular), electricity generating capacity and paved roads. Using overall roads as a goal, the estimated cost over 20 years is 4%, for paved roads, the needed investment is 6% per annum. See Appendix II for detailed results.

⁸ However, this could not be funded by public resources alone (or would require massive reallocation of resources): public expenditures amounted to an average of about 22% of GDP in the region in 2000-2001, with total public investments around 3% of GDP.

infrastructure affects the investment climate in which firms operate. Good infrastructure contributes to making firms more productive hence more competitive internationally. At the macro-economic level, the performance of infrastructure stock influences total factor productivity (TFP), generally referred to as the only quantifiable measure of competitiveness (Krugman 1994).⁹ It is also critical to countries' ability to reap the benefit of trade liberalization as infrastructure is central to the "behind the border" agenda. This is clearly topical in LAC, as trade liberalization continues to advance in many countries.

The poor performance of infrastructure variables contributes to the low ranking of Latin American countries in competitiveness indices. Several such indices, aggregating infrastructure variables, have been developed internationally. These include the World Economic Forum's Growth and Business Competitiveness Indexes and the International Institute for Management Development's (IMD) World Competitiveness Yearbook. These indices combine statistics and opinion data coming from firm surveys, to compare and rank the ability of nations to create and maintain an environment that sustains the competitiveness of enterprises. Firm surveys such as the World Bank's investment climate assessments (ICAs) also provide information on how firms perceive the environment in which they operate, notably the performance of infrastructure. As Figure 4 shows, 55% of survey respondents in LAC considered infrastructure to be a major or severe obstacle to the operation and growth of their business. That level (shared by MENA) is the highest in the world.

Figure 4: Businesses that see infrastructure as a serious problem

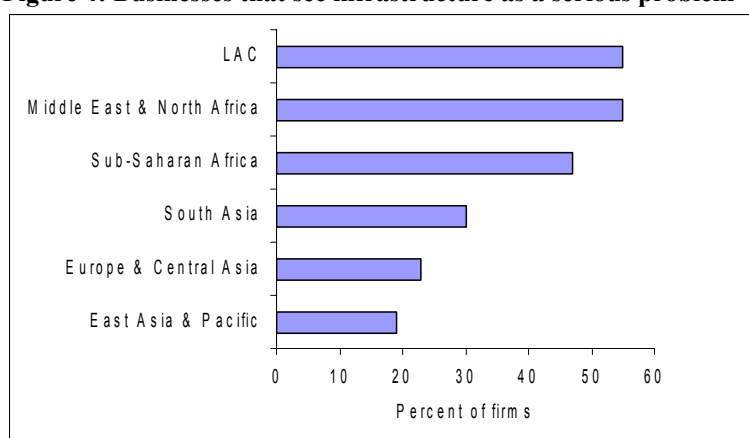

Source: World Bank 2004a based on Investment Climate Surveys data.

Note: Figure shows the share of firms that report any of electricity, telecommunications, or transportation as "major" or "severe" obstacles to the operation and growth of their business.

Latin American firms rank infrastructure as a serious problem, which negatively affects their productivity. Investment climate surveys completed in Brazil, Ecuador, El Salvador, Guatemala, Honduras and Nicaragua suggest that infrastructure is deemed a serious issue by most Latin American entrepreneurs. Indeed, an in-depth cross country analysis of the ICAs for those 6 Latin America plus Indonesia was conducted as background work for this report and confirms this finding: Escribano et al. (2005) find that infrastructure is a major determinant of TFP in the 6 LAC countries that were considered: the cumulated effect of infrastructure-related variables on

⁹ TFP is defined as the residual output not explained by capital or labor. Similarly growth in TFP is the growth of output not attributable to the growth in capital or labor.

TFP adds up to about 55% per country. Infrastructure variables with the highest impact on average productivity include poor electricity and transport services (Figure 5).

Figure 5: Productivity gains from a 20% improvement in selected investment climate variables by country (percent)

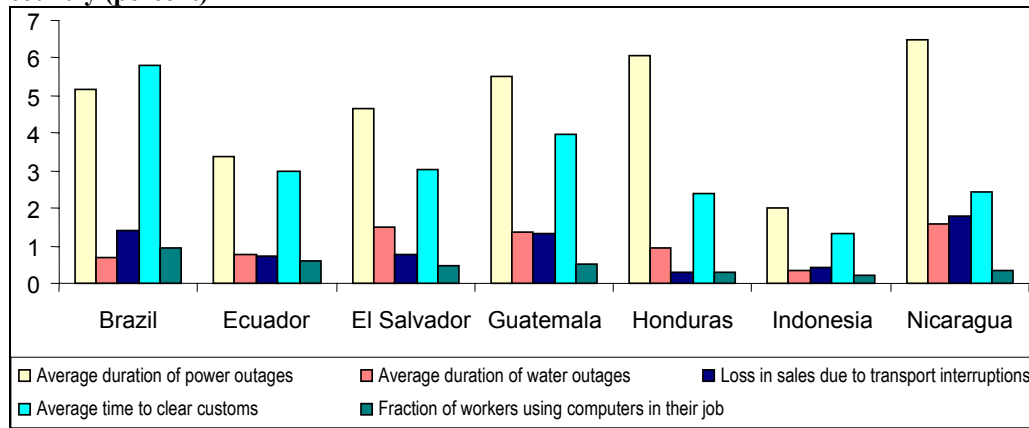

Source: Escribano et al. (2005)

Poor infrastructure also affects firms’ ability to export or attract foreign investments.

Escribano et al. also found the poor conditions of infrastructure in Latin America to affect firms’ integration into global markets. In particular, it affects the capacity of firms to export, as well as the ability of countries to attract foreign investments, thus reducing opportunities for greater international integration, higher competitiveness and enhanced technology and innovation.

Poor infrastructure also contributes to high logistics costs and requires high inventory levels in Latin America and the Caribbean.

Logistics costs range from a low of 15% of product value in Chile to a high of 34%, in Peru.¹⁰ The average in OECD countries is around 10% (Guasch 2002).¹¹ While part of this difference is due to the higher value relative to weight of OECD products, much of it can be attributed to differences in infrastructure quality and reliability. Poor quality and reliability require higher inventory levels. While U.S. businesses typically hold inventories of around 15% of GDP, inventories in Latin America and other developing regions are often twice that (Guasch 2004). Such levels are expensive to maintain, principally because they tie up capital which has a high cost in most of LAC. This significantly increases unit costs, diminishing competitiveness and productivity. Guasch estimates that, assuming an interest rate for financing holdings of 15-20%, the cost to an economy of additional inventory holdings is more than 2% of GDP.

¹⁰ Logistics cost is the cost of getting products from factory to markets) is very sensitive to the quality of infrastructure, especially transport. Unreliable or inexistent infrastructure will result in higher losses in transit, the need to hold higher inventory rather than order just-in-time, and generally higher cost of transport

¹¹ This is partly due to the fact that high income OECD countries’ exports have higher value relative to weight.

The fight against poverty and inequality has also been hampered

The recent expansion of infrastructure coverage has tended to benefit the poor but with some exceptions. As the poor, particularly in remote rural areas, are usually the last to be connected, the gradual recent expansion of services in Latin America can be expected to have benefited them more than the better off. But country data presents a mixed picture (Estache, Foster and Wodon 2002). For example, Brazil made great progress in providing water access to the lowest urban income decile between 1989 and 1996. The proportion of this group with access jumped from 53% to 74%, against a rise from 92% to 97% for the seventh decile. But in rural areas, absolute increases benefited the seventh decile more than the poorest: coverage in that group rose from 64% to 77% but only from 12% to 21% for the bottom decile. Similarly, over the same period, Mexico's electricity coverage fell slightly for the urban poorest and rural seventh deciles, barely changed for the urban seventh decile and jumped for the rural bottom decile.

Infrastructure access is critical for improving economic opportunities for the poor. As poorer individuals and underdeveloped areas become connected to core economic activities, they can access additional productive opportunities (Estache 2003). Likewise, infrastructure development in poorer regions reduces production and transaction costs (Gannon and Liu, 1997). For example, in poor rural areas infrastructure expands job opportunities for the less advantaged by reducing the costs of accessing product and factor markets (Smith et al. 2001). And infrastructure access can raise the value of the assets of the poor. Recent research links the asset value of poor farm areas - as proxied by the net present value of the profits generated by their crops —to the distance to agricultural markets. Improvements in communication and road services imply capital gains for these poor farmers (Jacoby 2000).

Evidence of complementarities across infrastructure services suggests the need to promote access to a bundle of services. Chong, Hentshel and Saavedra (2004) find that urban households with access to more than one service (e.g. water, sanitation, electricity and telephone) tend to do much better than those with only one, with the effect of multiple services being multiplicative rather than additive. Similarly, Escobal and Torero (2004), relying on rural data for Peru find a significant impact on both agriculture productivity and diversification outside agriculture. Both sets of studies address the issue of reverse causality (richer people buy more infrastructure services) so that the net effect they estimate does argue in favor of bundling infrastructure services for the poor, in order to maximize their impact on rural households' incomes.

Improved infrastructure also affects the health and education levels of the poor. For health, access to clean water and sanitation is clearly fundamental. Diseases from drinking contaminated water and a lack of safe water and sanitation for household hygiene are among the main causes of child mortality (World Health Organization 2002). In Argentina, a recent study by Galiani et al. (2005) finds that child mortality fell by 8% in areas which had privatized water utilities (and hence experienced improved coverage and quality), with most of the reduction occurring in low-income areas where the water network expanded the most. More generally, Fay et al. (2005) find that allowing the poorest quintile in developing countries the same access to basic services as the richest would reduce child mortality by 8% and stunting by 14%. There are other, less obvious, linkages (explored in Brennenman 2002). Improved transport facilitates access to healthcare, as well as easier staffing and operation of clinics. For girls, enrollment is also helped by greater access to piped water, which would otherwise have to be fetched. Electricity also allows more time for study, while the positive health impacts of clean water allow more time in the classroom.

Perhaps as a result, improved infrastructure reduces income inequality. Calderón and Servén (2004) find a significant impact of infrastructure access and quality on overall inequality. This is particularly important for two reasons: (i) Latin America is the most unequal region in the world, with a Gini coefficient estimated at 50.5; (ii) reducing inequality is very difficult. Indeed, Latin America's Gini has hovered around 50 for at least the last 25 years (De Ferranti et al. 2004). Calderón and Servén's work suggest that if Latin American countries raised their infrastructure stocks and quality to the levels of the region's leader, Costa Rica, their Gini coefficients would fall by between 0.02 and 0.10 (Table 4). Catching up with the East Asian median country, the Republic of Korea, would entail drops of 0.05 and 0.13. These are significant changes.

Table 4: Changes of inequality (Gini coefficient) in LAC countries due to higher infrastructure development

Country	Improvement to levels of LAC leader			Improvement to levels of EAP median		
	Stocks	Quality	Total	Stocks	Quality	Total
Argentina	-0.03	-0.01	-0.03	-0.05	-0.02	-0.06
Bolivia	-0.08	-0.01	-0.09	-0.10	-0.02	-0.12
Brazil	-0.03	-0.02	-0.06	-0.05	-0.03	-0.09
Chile	-0.03	0.0	-0.03	-0.05	-0.01	-0.06
Colombia	-0.04	-0.02	-0.06	-0.06	-0.03	-0.09
Costa Rica	-	-	-	-0.02	-0.01	-0.03
Dominican Rep.	-0.03	0.0	-0.03	-0.05	-0.01	-0.06
Ecuador	-0.04	-0.02	-0.06	-0.06	-0.03	-0.09
Guatemala	-0.07	-0.01	-0.08	-0.09	-0.02	-0.11
Honduras	-0.07	-0.02	-0.09	-0.09	-0.03	-0.12
México	-0.03	0.00	-0.03	-0.05	-0.01	-0.06
Nicaragua	-0.07	-0.02	-0.10	-0.09	-0.03	-0.13
Panama	-0.03	0.00	-0.03	-0.05	-0.01	-0.10
Peru	-0.06	-0.01	-0.07	-0.08	-0.02	-0.10
El Salvador	-0.03	-0.01	-0.04	-0.06	-0.02	-0.07
Uruguay	-0.02	-0.01	-0.02	-0.04	-0.02	-0.05
Venezuela	-0.02	-0.01	-0.03	-0.04	-0.02	-0.06

Source: Calderón and Servén (2004)

In sum, coverage and quality of infrastructure has improved in Latin America over the last decades, but not enough. The result is that the region has lost ground relative to peers or countries whose economic success could be emulated and has become less competitive. It also has meant less progress than could have been possible in reducing poverty and improving the standard of living and economic opportunities of the poorest. The next section turns to some explanations for this somewhat disappointing performance.

AT ISSUE: INSUFFICIENT IMPROVEMENT IN THE MANAGEMENT OF TOO FEW RESOURCES

Latin American governments massively reduced their infrastructure investments in the nineties. This was due to the combination of fiscal austerity in a number of countries in the region and the emergence of a new paradigm for infrastructure provision. Regulatory and financial innovation made it increasingly possible to delegate the financing and management of infrastructure to the private sector.

The thought was that the private sector would make up the financing shortfall and improve performance as well, but results fell short of expectations. Some countries and sectors proved much more attractive to the private sector; countries varied about which sectors they opened up to private participation and how this was structured. Cost recovery – essential for private participation without public subsidies – proved elusive. And regulatory and governance hurdles turned out to be larger than expected.

All this has resulted in a perhaps excessive disappointment with PPI. Evaluations show that PPI has in fact generally been beneficial, bringing improved quality and coverage. While prices often increased following privatization or concession, profits of concessionaires were not generally excessive. More importantly, analysis shows that the benefits of privatization are affected by how well it is structured and monitored by Governments. And improvements in performance are critically linked to improvements in the regulatory framework. As for the distributional impact, this is largely determined by governments' decisions on whether pursue a redistribution agenda. The conclusion therefore is that the public sector continues to have an essential role to play both in providing the regulatory environment and in direct provision of infrastructure.

Private entry could not make up for public retrenchment

Public infrastructure investment has borne the brunt of fiscal adjustment. State spending on infrastructure plummeted in all countries considered except Colombia, as a direct result of the fiscal austerity forced by the region's macroeconomic crises over the last 20 years (Figure 6.b). Public investment in infrastructure and the primary deficit have followed remarkably similar paths over the last 25 years. From 1980 to 1998, a contraction in infrastructure investment contributed significantly (i.e. a third the correction or more) to the adjustment in five of eight adjusting economies considered (Table 5). The reduction was particularly sharp in Brazil, where public investment in infrastructure fell by much more than the improvement in the fiscal balance and current expenditures actually increased.

Figure 6: Infrastructure investment in major countries (percentage of GDP)

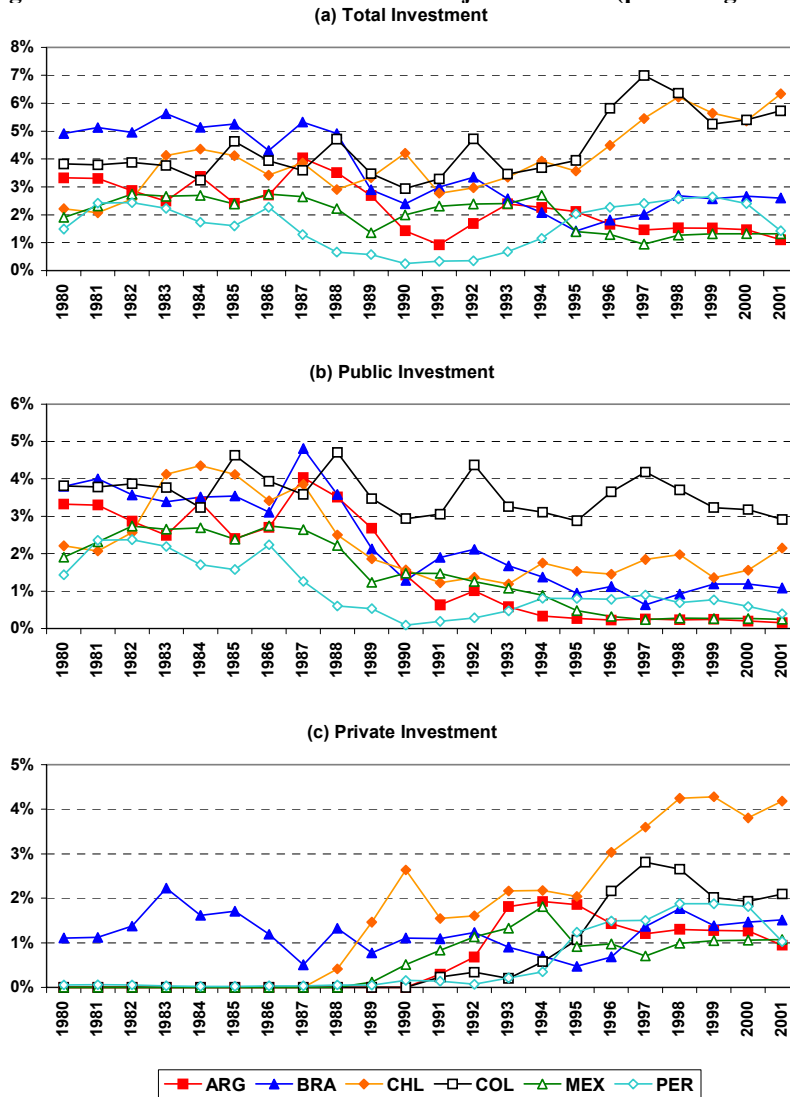

Source: Calderón and Servén (2004a)

At the same time, Latin America managed to attract half of the developing world’s PPI. Half (48%) of the \$786 billion of private participation in developing country infrastructure between 1990 and 2003 went to Latin America.¹² As a result, average annual private infrastructure investment rose significantly in the 1990s in all countries considered except Brazil, where it continued to hover at around 1% of GDP (Figure 6.c). The increase was particularly marked in Bolivia and Chile, where private funding reached respective averages of 4.4% and 3.9% of GDP for 1996-2001.

¹² This can be explained by a combination of factors: the region was a pioneer in opening its infrastructure sector to private sector participation, expected growth was reasonably high, the macroeconomic environment appeared stable and the region was shifting towards greater economic openness (Sirtaine 2005).

Table 5: The contribution of infrastructure to fiscal adjustment, average 1980-84 vs average 1995-98

	Change in public investment/GDP		Change in primary surplus/GDP [3]	Contribution of investment reduction to fiscal adjustment (%)	
	Total	Infrastructure		Total	Infrastructure
	[1]	[2]		[1]	[2]
Argentina	-3.97	-2.85	5.31	74.7	53.8
Bolivia	0.91	-3.1	6.15	n.a.	50.3
Brazil	-2.8	-3.08	1.77	158.1	174.3
Chile	-0.94	-1.41	2.39	39.2	58.8
Colombia	-0.45	0.04	4.69	9.6	n.a.
Ecuador	-1.57	0.68	1.81	87.0	n.a.
Mexico	-6.09	-1.98	6.28	97.0	31.5
Peru	-4.1	-1.51	3.11	132.0	48.6
Venezuela	-3.49	-0.41	-1.88	n.a.	n.a.

Source: Calderón, Easterly and Servén (2003)

PPI took many forms, with full privatization accounting for a fifth of transactions but half of financial flows (Figure 7). In the period 1990-2003, concessions accounted for 76% of the region's 999 projects (of these 45% were greenfield projects and 31%, concessions of existing assets), divestitures 22%, and management and lease contracts a mere 3%. In terms of financial flows, divestitures predominated, generating 53% of the \$374 billion total value of projects with PPI, while greenfield projects represented 29% and concessions 17%.

Figure 7: The different forms of PPI in LAC (1990 to 2003)

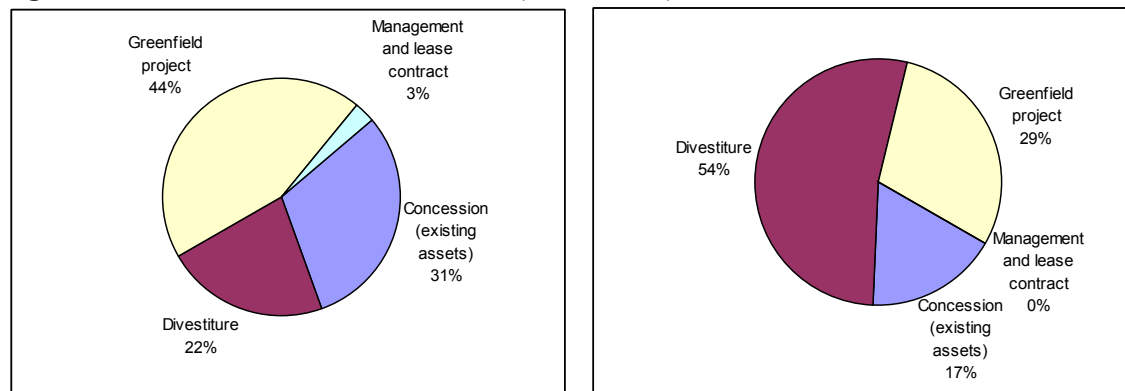

(a) by project count

(b) by financial flow

Source: World Bank PPI projects database

PPI has transformed infrastructure provision in the last two decades. At the start of 1990, only 3% of telephone and electricity connections in the region were provided by private companies, and almost no water utilities were in private hands. By 2003, private utilities were managing 86% of telecom subscriptions and 60% and 11% respectively for electricity and water connections (Andres, Guasch and Foster 2005).

But PPI has been uneven across countries and benefited certain sectors more than others. Six countries (Argentina, Brazil, Chile, Colombia, Peru, and Mexico) absorbed 93% of LAC's PPI. As to sectors, telecommunication absorbed the bulk of regional PPI (46%), followed by

energy (32%) and transport (17%), with water and sanitation taking in only about 5%. This is consistent with Calderón and Servén’s (2004a) finding that total investment in telecoms rose in all seven countries in their sample, while that for transport and power fell in most of them. It also reflects the uneven pace and depth of reform across these sectors (Box 2).

In addition, not all private inflows went into new investments. A third of the region’s PPI transactions represented payments to governments (license fees, canon payments or divestiture revenues), reducing the total value of new investments in facilities to \$255 billion (still 45% of the total for such investments worldwide). In addition, these data represent the total value of projects with private participation, and therefore also include some public investment. As such, the figures overstate the actual flows of private investments to infrastructure in Latin America

PPI has collapsed since 1998 and shows no sign of recovery. Since 1998, private investment levels have collapsed, with the conclusion of major divestiture programs and weaker investor interest. Total investment in infrastructure projects with private participation dropped from \$71 billion in 1998 to \$16 billion in 2003. Forms of PPI have also changed markedly: there were no divestitures in 2003, greenfield projects accounted for 72% of transactions while concessions of existing assets amounted to a mere 13% (Figure 8). There appears to have also been a resurgence of management and lease contracts, with 6 signed in 2003, representing 15% of total deals.

Figure 8: Changing forms of PPI in LAC since 1990 (by project count)

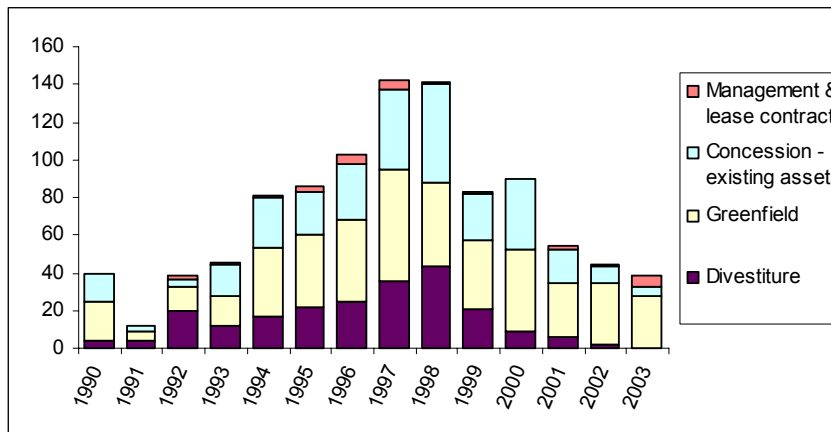

Source: World Bank PPI projects database

Overall, private investment failed to make up for public cutbacks, so total infrastructure investment fell sharply in most of Latin America. While public funding dropped from 3.1% of GDP for 1980-1985 to 0.8% of GDP for 1996-2001 in the seven major Latin American countries considered in Figure 3a, private investments increased on average only from 0.6% to 1.4%. As a result, the overall level fell from a weighted average of 3.7% of GDP in 1980-85 to 2.2% in 1996-2001. Only Colombia and Chile were exceptions, witnessing a substantial expansion over the last decade. By one set of estimates, even at the peak, PPI was nowhere close to satisfying all infrastructure investment needs in Latin America (Fay 2001).

Box 2: The uneven pace of reform across sectors

Privatization has gone furthest in the telecommunications sector. In most countries, state-owned companies operated fixed telephone monopolies in the 1980s. Privatization began with Chile (1986), Jamaica (1989), Argentina (1990) and Mexico (1990) and subsequently spread throughout the region. Only six Latin American countries still have public telecommunications firms: Colombia, Costa Rica, Ecuador, Honduras, Paraguay and Uruguay. Region-wide, around 86% of fixed telecommunications subscribers were served by the private sector in 2003, up from almost zero at the start of 1990 (Andres, Foster and Guasch, 2005). Majority stakes in state companies were sold, with new owners typically bound by commitments to expand networks and meet quality standards. In return, they were granted a period of monopoly operation, lasting five years on average, after which markets were opened to competition from new operators (Andres, Foster and Guasch 2005). In a second major wave of reforms, long-distance services were liberalized from 1994 (Chile) onwards. The cellular sector has been characterized by significant private participation from the outset, and competition has increased gradually. The larger countries of the region all have at least three mobile operators now.

In Latin America and worldwide, reforms in the electricity sector have followed a similar pattern, but are at different stages. Chile was the pioneer, privatizing its major electric utilities between 1986 and 1989. It was followed by Argentina (1992) and then Bolivia, Colombia and Peru. In the late 1990s, Panama, El Salvador, Guatemala, Nicaragua, Honduras and Brazil also undertook reform, including the establishment of regulatory boards to set quality standards, regulate tariffs and monitor the compliance of private operators. More recently, Costa Rica, Ecuador and Venezuela have started restructuring. But a number of countries, including Paraguay and Uruguay, have done little to date. Overall, around 60% of electricity connections were served by private distributors in 2003, up from 3% in 1990 (Andres, Foster and Guasch 2005). Recent reforms have had five common themes (Estache and Rossi 2004): (i) unbundling of generation, transmission and distribution activities; (ii) privatization of the assets (for generation) or of the management of those assets (for transmission and distribution); (iii) promotion of competition *in* the market in generation; (iv) promotion of competition *for* the market in other segments (typically through competitive bidding to operate transmission or distribution on a monopoly basis); and (v) increasing the incentive power of the residual regulation needed.

The diversity of the transport sector means private participation has taken many forms, with concessions of existing infrastructure being the most common. Even within sub-sectors, reforms have followed different paths. Among ports, stevedore activities have been outsourced (Colombia, Ecuador), landlord port concessions developed (Argentina, Chile, Panama) and port authorities have even been concessioned (Colombia). In Central America (eg. Costa Rica, El Salvador, Guatemala, Nicaragua), port reforms are still pending and private sector participation remains limited. Private sector participation in urban transportation services (Chile, Colombia) and infrastructure (Chile) has taken many form. In the railroad sector (freight only), concessions have been successfully developed in Argentina, Chile and Mexico. In many LAC countries, the level of competition in road transport services remains low, due to oligopolistic behavior and resistance to regional integration.

Reforms and private participation have been more recent and less common in the water sector. Local governments have generally—and increasingly—managed water and sanitation services in the region, so there has been less scope for sector restructuring on a national level. As a networked industry with high fixed costs, competition is inherently limited in large-scale water or sewerage provision. The fact that safe water is essential for life and health also supports a greater state role in promoting its availability and affordability, while the potential implications for social welfare of any changes in service provision make these more politically sensitive. Some equity sales have taken place in the sector in LAC, starting with Chile's EMOS (later Aguas Andinas SA) and other companies in 1990. But private participation has more often come through concessions or management contracts. Only about 11% of water distribution (by number of connections) in LAC was by private operators in 2003, up from almost none in 1990 (Andres, Foster and Guasch, 2005.) As well as Chile, countries with some private participation include Argentina, Bolivia, Brazil, Colombia, Ecuador, Honduras, Mexico and Trinidad. Those without include Ecuador, Peru and Venezuela.

WHO OR WHAT IS TO BLAME FOR THE GROWING DISENCHANTMENT WITH PPI?

In recent years, public opinion turned against PPI and investors' appetites waned. In November 2000, 36% of Argentines believed that infrastructure services should come back under Government control. Five years later, 78% do.¹³ This reflects a general trend in Latin America: with the exception of Panama, about 40% of the population was expressing discontent with privatization in 1998; today the average is closer to 75% (Figure 9). Public opposition has become a real constraint on PPI in some countries, both politically and operationally. At the same time, the private sector seems to have lost its appetite for infrastructure: the average number of bidders for power distribution privatizations in Latin America fell from over four in 1998 to less than two in 2000 and 2001 (Harris 2003).

Figure 9: Population expressing dissatisfaction with privatizations (percentage)

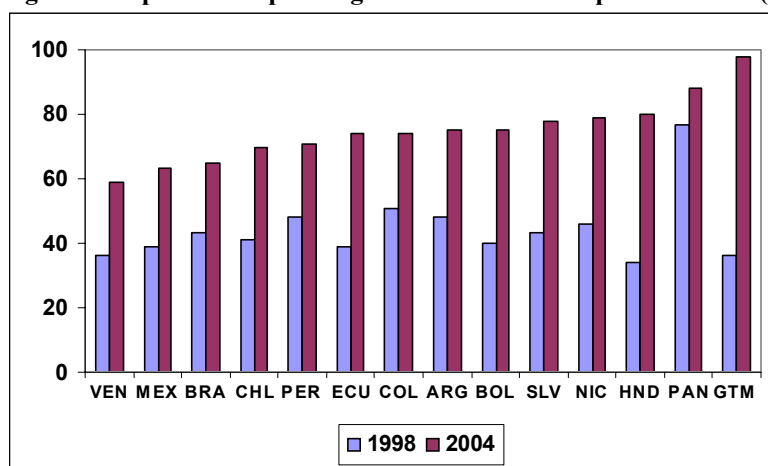

Source: Latinobarómetro surveys for 1998 and 2004

Note: The 1998 results reflect survey respondents who disagreed or strongly disagreed with the statement, "privatizations of state companies have been beneficial for the country." The 2004 numbers are of those who were less satisfied or much less satisfied with public services after privatization, in terms of price and quality

However, the verdict on PPI is actually rather positive. As discussed below, the impact of PPI on coverage and service quality has generally been good and concessionaires have not had fared: while analysis shows that concessions are capable of generating adequate returns in the long term, they are clearly a risky business (Sirtaine et al 2005). Popular discontent and private sector disaffection may be due to excessive renegotiations and a few well publicized failures as well as to poor management of the political economy of reform. These are discussed in turn below after a review of the impact of PPI.

The impact of PPI has been mixed, but positive overall

PPI has generally boosted coverage and service quality in most companies involved. Most studies have found that the private sector tends to do at least as well, and sometimes better than the public sector in expanding service, customer numbers and coverage areas, and also in

¹³ As reported in El Cronista, April 18 2005 "La mayoría cree que los servicios públicos deben volver al Estado".

enhancing quality. In many cases, the greatest expansion comes through increased investment, which allows companies to meet increasing demand and serve previously unattended consumers (Harris 2003). In La Paz-El Alto, Bolivia, the rate of new connections to water and sanitation services increased by two thirds following the entry of the private sector. In El Alto, the coverage of sewerage services had been unchanged for a decade under public ownership but increased by 30% in the first three years of private participation (Foster and Irusta 2001, cited in Harris op. cit.) Andres, Foster and Guasch (2005) find that private sector entry generated significant improvements in quality in LAC's fixed telecom, electricity and water sectors, from a study of 181 companies. Service expansion accelerated significantly in the telecommunications sector, and to a lesser degree in electricity distribution.

Labor productivity has generally increased with reform and PPI, with the main change coming during the transition to private ownership, amid heavy job losses. Estache and Rossi (2004) find that there were substantial increases in labor productivity, of about 6% a year, in Latin American electricity distributors in the post-reform period (1994-2000), and that private firms used about 30% to 45% less labor to produce a given bundle of outputs than public firms. However, Rossi (2004) qualifies this result by arguing that outsourcing may be biasing these results, as firms' operating and maintenance expenses did not change significantly after the reforms. Andres, Foster and Guasch (2005) find, from a study of privatized firms in the region, that labor productivity increased significantly in electricity distribution, fixed telecommunications and water distribution. Improvements generally took place during the transition, and were due in large part to sharp reductions in the workforce.

Reform and private participation have also boosted both quality and coverage in LAC, although the impact varies considerably between sectors. Andres, Foster and Guasch (op. cit) find that for electricity distribution, output and coverage improved following private entry, but these were driven by the underlying trend. Quality indicators and distributional losses showed significant improvements, mostly during the transition (the period during which enterprises to be privatized were being restructured for the sale). In fixed telecommunications, coverage increased significantly both during and after the transition and after it, over and above the existing positive trend. Quality, as measured by the percentage of completed calls, improved by 42 percent over the whole period considered, with most of the change coming after the transition. In water distribution, there were significant increases in coverage and the number of subscribers, but these were broadly in line with the trend. Quality, reflected in both continuity of service and potability, showed strong improvements. Most of the change in potability came during the transition, while continuity improvements came afterwards.

PPI and recent reforms have had a generally positive effect on the poor.¹⁴ Reforms have sought to promote access and affordability. However, access expansion may be curbed by high connection charges, or regulations that limit the alternatives to conventional utility provision, while affordability may be affected by tariff reforms and the tightening of standards for quality of services. The empirical evidence suggests that the impact of reforms on the poor and other income groups has varied, according to the particular nature of the reforms undertaken. In the case of Argentina, Chisari et al. (1999) and Navajas (2000) showed that the privatization of infrastructure service may have benefited the poor more than others by granting them increased access to services. On the other hand, Estache, Gomez-Lobo and Leipziger (2000) argue that the poorest groups of the population did not have access to many utility services and did not benefit from their expansion prior to the privatization. More recently, McKenzie and Mookherjee (2003)

¹⁴ See Estache, Foster and Wodon (2002) for a more in depth discussion.

review in depth studies on privatization in Argentina, Bolivia, Mexico and Nicaragua and conclude that privatization had overall positive effects on the welfare of all consumers and that except for one case (electricity in Nicaragua), inequality decreased following privatization.

The record on employment is mixed. There were substantial layoffs in the privatized firms – cutbacks ranged from 30% to 75% in the cases reviewed by McKenzie and Mookherjee. But layoffs were small relative to the overall workforce with the exception of Nicaragua where they reached 7% to 9%.¹⁵ And layoffs were generally reversed in the medium run. No clear pattern emerges as to the impact of privatization and the subsequent labor restructuring on wage inequality. McKenzie and Mookherjee conclude that the effect of privatization is likely to be small and dominated by other changes in the economy – a claim supported by others (Martimort and Straub 2005).

Contrary to common perception, concessionaires don't appear to have made excessive profits. Analyzing a representative sample of 34 regional private infrastructure concessions, Sirtaine et al. (2005) find financial returns have in fact been modest (given a high estimated cost of cost of capital). On average, concessions only seem to become profitable after 10 years of operation, probably reflecting high investments made in the early years. However about 40% of projects did not appear to have the potential to generate attractive returns, given the considerable risks involved, with the proportion rising to 50% in the energy and transport sectors. In fact, it is only in telecommunications that, with historical growth maintained, concessions seem inherently profitable. Concessions in the water sector seem to offer the least attractive returns.

However, these results must be treated with caution. The estimated rate of return is very sensitive to the estimated cost of capital as well as the estimated investments. Sirtaine et al. (2005) deal with these two issues as best they can (in particular they use realized investments rather than commitments). In addition, renegotiation can significantly improve the profitability of concessions (indeed this is possibly why concessions become more profitable in the longer term). And regulatory systems often provide the incentive for firms to under-report profits, without including sufficient safeguards to stop them doing this, as is discussed below in the context of regulatory accounting. Overall, however, the limited enthusiasm for infrastructure concessions that currently characterizes the private sector supports Sirtaine et al's findings.

However, there have been too many renegotiations and some well publicized failures

Concessions, whether for existing assets or greenfield projects, have been the main vehicle for PPI in LAC. (See Box 3 for a definition of concessions) While outright privatizations have often been used in LAC for airlines, other transport operators, telecom companies and electricity generators, such sales may be prevented by laws, constitutions or public or political opposition. Government concerns about the performance of infrastructure industries may also lead them to retain ownership. Overall, concessions have been more common than divestitures in LAC, particularly for roads, airports, ports and WSS.

¹⁵ Mc Kenzie and Mookherjee (2003) also report job losses to have been 0.13% in Bolivia, 1% in Mexico and 2% in Argentina. These refer to job losses from privatization in general, not just of infrastructure.

Box 3: Definition of concessions

Concessions give a private investor the right to operate a service over a defined period, usually 15 to 30 years, subject to meeting investment and operating requirements. They are usually awarded on the basis of a competitive bidding process and do not usually transfer ownership of the assets employed. Concessions encompass not only the use of existing assets but also greenfield projects, particularly through build-operate-transfer (BOT) contracts, which have been common for power plants and gas transmission pipelines in LAC, and have also been used in WSS.

Too many concessions have been renegotiated. Some renegotiation is inevitable and even desirable, to improve concession design, promote efficiency and remedy contractual incompleteness. But Guasch (2004)¹⁶ finds that of more than 1,000 infrastructure concessions granted in the LAC region during 1985-2000, 30% were renegotiated. Excluding telecom concessions (of which there are relatively few) raises the incidence to 42%, with rates of 9.7% for the electricity sector, 55% in transportation, and a staggering 74% in WSS. Concessions were usually renegotiated soon after their award, with an average of 2.2 years between the award and renegotiation. Time elapsed was shortest for WSS (1.6 years) and longest for the transportation sector (3.1 years).

Frequent revisions may indicate that either new operators or governments have behaved opportunistically. Concessionaires initiated 61% of renegotiations, often to improve on unrealistically low bids (60% of contracts awarded on the lowest proposed tariffs were renegotiated, against only 11% of those based on the highest.) And higher tariffs have usually resulted (62% of cases), with negative impacts for consumer welfare. But the high sunk costs of infrastructure investments may also tempt governments to expropriate more of the rents from these, in the knowledge that investors cannot withdraw easily (Guasch, Laffont and Straub 2005) Examples include the cancellation of the La Paz and El Alto water concessions in January 2005, but there are many others (Box 4).

Renegotiations may also be due to poorly designed contracts and/or regulatory weakness. Modes of regulation also matter. For example, price caps, which have been common in Latin American concessions are vulnerable to shocks and lead to frequent renegotiations. A strong regulator is also a desirable counterpoint to political opportunism and is particularly important where there is weak governance – its presence reduces renegotiations both government and concessionaire led. Guasch, Laffont and Straub (2003) estimate the rate of concession renegotiation to be 61% in the absence of a regulatory agency is not in place, against 17% when one was.

Whatever the motivations, frequent renegotiations are costly. Renegotiations introduce uncertainty and reduce transparency as new terms are determined by the relative bargaining power of the concessionaires and governments, rather than through competitive processes. As a result there are costs. In particular, it bids up the cost of capital as investors demand a risk premium to offset the potential risk. Guasch and Spiller (1999) estimate this to range from 2 to 6 percentage points depending on the country and sector. In addition, there are other costs, such as widespread disruption of service or failure to meet expansion goals.

¹⁶ The data and discussion on renegotiation in the following paragraphs are also drawn from this source.

Guarantees have exposed governments to enormous contingent liabilities. In many countries, governments provided guarantees of service demand or exchange rate levels in early PPI contracts for power generation plants, toll roads and other projects. Payments under such guarantees, which were often based on overly optimistic projections, have been triggered in a number of cases. In Colombia, for example, potential cumulative payment obligations over the life of PPI contracts has been estimated to represent as much as 4% of one year's GDP. Payment obligations the new Termopaipa and Termobarranquilla generating facilities already amounted to \$1.5 billion in 2003, and were projected to rise to \$3 billion by the 2014 contract expiration (World Bank 2004b). The 1997 Mexican toll-road program bailout cost between US\$7 and US\$12 billion (1% to 1.7% of Mexico's GDP) (Guasch, Laffont and Straub 2005).

A few privatizations have not produced the desired results, but such cases have not been the norm. A case in point is the privatization of the electricity sector in the Dominican Republic where concessionaires' inability to resolve problems in distribution more than offset the gains from increasing private sector investments in generation. The result was the power sector crisis of 2002: in September 2002, over half of the circuits of the main distribution company were out of service. The resulting riots claimed 15 lives (World Bank 2005a). Today, the sector still relies on substantial subsidies from the Government in order to function. And in some cases, mismanagement by authorities is largely responsible – as in the financial collapse of toll road concessions in Mexico mentioned above.

Box 4: Some examples of government-induced concession disputes

As of 2005, most of the concessions awarded in Argentina prior to the 2001 crisis are still undergoing protracted renegotiation processes. Conflict arose as the government converted the dollar-denominated rates to devalued pesos, despite contract clauses that allowed for indexation to the dollar and US inflation, and refused any subsequent significant rate adjustment. Despite 62 firms' suits before the World Bank's International Centre for Settlement of Investment Disputes, Argentina has been very slow in responding to those challenges, arguing the need to protect the interest of the Argentine people. It has also argued that international arbitration decisions should be reviewed by local judicial courts, despite the country's agreement to abide to international arbitration, under bilateral investment treaties signed by the government of Carlos Menem in the 1990s.

Similarly, the Limeira water concession in Brazil was denied the automatic tariff adjustments allowed by the contract. The local mayor argued that the contract, signed by a previous administration, was unfair and compromised the municipality's long term interests. Similar behavior plagued the Tucuman water and sanitation contract in Argentina. In 1995, a new local government took office and sought to limit previously agreed upon tariff increases. This finally led the concessionaire to abandon the concession in 1996. In the toll road concession in Pernambuco, Brazil, the regional government decided to cut the tariffs unilaterally shortly before elections.

Sometimes, lack of commitment shows up at even earlier stages, like in the case of the 1999 Matarani port concession in Peru, where the rules of the tender were changed unilaterally in the awarding period (shortening the duration of the concession from 30 to 15 years in the other one).

Source: Guasch, Laffont and Straub 2005

The process has suffered from macro shocks and poor management of the political economy of reform

Disaffection with emerging markets and setbacks suffered by major investors have curbed private sector interest. In addition to concerns about renegotiations and expropriation, investor interest has suffered from the general disaffection with emerging markets that followed the East Asian, Russian, Brazilian and Argentine crises. Greater perceived risk has led to caution among both infrastructure companies and financial investors. Currency depreciation in Argentina and Brazil, in particular, has made investors less willing to engage in projects in which revenues are in local currency but financing is in foreign currency, as is typically the case for infrastructure projects with PPI. Several of the major players in infrastructure have suffered commercial or share price setbacks of varying degrees (Enron, AES, Suez, Vivendi).¹⁷ Although a number of new entrants, notably from developing countries, have emerged, they are unlikely to fill the gap (Harris 2003).

More generally, PPI is very vulnerable to economic downturns. Recent events illustrate that government-related risk, notably regulatory risk, worsens at times of economic turmoil as low demand makes it harder to pass on costs. Similarly, foreign exchange pass-through becomes unsustainable under high depreciation. The treatment of private contracts in the context of recent events, such as the Argentinean crisis, also damaged private investors' confidence in relying on specific clauses in the project contract to ensure protection against some risks (such as tariff escalation clauses linked to the exchange rate, and compensation clauses in case of regulatory changes) (Sirtaine 2005). Nevertheless, shocks cannot be blamed for all the setbacks suffered by PPI. Instead, they mostly revealed weaknesses in regulatory frameworks and only exacerbated an already difficult cost recovery goal as discussed in the next section.

Macro downturns also worsen public attitudes towards market mechanisms. In a detailed analysis of factors affecting the public perception of privatization, Boix (2005) finds that privatizations have been associated in the public mind with poor economic performance. His argument is that the public operates with limited information about the mechanisms that lead to growth and therefore imputes economic performance to the highly symbolic decisions around which governments build their economic policies. Thus, as economic performance worsens, so do public views about privatization and similar market mechanisms.

Public perceptions of privatization are also colored by whether the deals are seen as fair (Boix 2003, Martimort and Straub 2005). This may be a rational evaluation of the process, or it may be affected by views about the transparency of the process and corruption in public affairs. It may well be a reaction to the fact that, in many cases, Government used the proceeds of privatization for general budgetary processes, rather than to compensate losers (e.g. individuals who lost jobs as a result of the process) or fund well targeted subsidy schemes to offset needed tariff increases.¹⁸ Box 5 looks in more detail at the possible reasons for the social discontent with privatization.

¹⁷ As Harris (2003) points out, AES, which has been one of the largest PPI players in Latin America, saw its stock price fall from over \$70 per share in October 2002 to around \$1.4 in late 2001. (While it has improved it never fully recovered – as of May 2005, it was about \$14.6.) Similarly Vivendi and Suez saw their shares decline by half from their peak level.

¹⁸ Although privatization may have overall beneficial effects, perception will be determined by individual gains and losses that are likely to differ across groups. In addition, as with trade liberalization, gains are

Behind the disappointment lie unrealistic expectations.¹⁹ Governments sometimes used privatization to help finance needed investments in services that were under-priced or to offload the responsibility for sector reform to the private sector. The example of electricity privatization in the Dominican Republic mentioned earlier is a case in point where the distribution companies were left to carry the burden of reducing losses and improve collection without adequate support from the authorities.

But privatization does not alter the fact that someone has to pay for the services (taxpayers or users) or assets will be depleted. This was overlooked by a number of governments, who assumed that the efficiency gains brought about by the private sector would be sufficient to offset the need for cost increases. Others may have over-estimated their ability to weather the political fall-out from price increases. As for private investors, they too may have overestimated the ability or determination of governments to abide by their commitments.

likely to be dispersed (across individuals and over time), while losses are likely to be concentrated (amongst individuals and in the present – as in the cases of job losses due to privatization or price increases).

¹⁹ See Harris 2003, on which this paragraph is based, for a more in depth discussion.

Box 5: Hidden failures and perception management: explanations for social discontent about privatization

There is a remarkable contrast between generally positive evaluations of privatization and the extreme public disaffection of it. Martimort and Straub (2005) in a paper commissioned for this report, review the literature for possible explanations for this paradox. This review leads them to the conclusion that either important failures have gone unreported (although clearly not unnoticed by those who suffered) or there has been a major problem with perceptions (and therefore a massive communication failure):

Hidden failures

While estimates of impact on service coverage and quality, and redistribution are generally positive, it is possible that some negative aspects were under-reported. First, the evidence on quality improvement is partial, and it is conceivable that quality may have deteriorated or at least failed to improve as much as expected. Some cases have reported dissatisfaction with quality (Mexico; electricity in Brazil and Chile). In addition, there are cases where quality improvements were insufficient to compensate for price increases.

Second, the re-distributional impact of price increases may not have been sufficiently mitigated by subsidies (which are often inefficiently administered). The modality and speed of price adjustments have also generated criticisms. Third, the record on job losses is clearly negative although the argument is that losses tended to be reversed in the medium term. It is possible however, that for all but the most skilled, the job transition resulted in lower quality of employment. There is indeed some evidence that stable or increased wages were the consequences of longer hours worked.

Perceptions and the political economy of privatizations

Negative public perception of privatization may be due to the downturn in the economic cycle as Boix (2005) documents. In particular, it is not clear how the public distinguishes job losses due to recessions from those due to the privatization process as they may all be lumped together in a source of discontent. Second, perception may have suffered from a gap between actual and expected performance. Many of the points about hidden failures can be rephrased from that point of view, as public discontent may be linked to a disappointment with outcomes that did not match initial expectations. Third, it is unclear what the public perception of frequent renegotiations and (rare but well publicized) cancellations have been – but they must have been significant.

Fourth, the perceived transparency of the privatization process is likely to be crucial in shaping public perceptions. Boix (2005) confirms the Lora and Panizza (2002) finding that negative opinions on privatization are stronger where corruption is perceived as more common. Corruption has a destructive effect on privatization as it affects competitive bidding and results in the allocation of rent towards a specific group. Corrupt deals may also be used to maintain monopoly power and impede the introduction of competition in privatized sectors – in which case post-privatization profits may be the result of monopoly rent rather than efficiency gains. Manzetti (2000) argues this was the case in telecoms in Argentina and in the electricity sector in Chile. Overall, it is unclear whether corruption has in fact increased or decreased as a result of the privatization process. One argument is that petty corruption is easier in public utilities, but that privatization offers the opportunity for grand-level corruption.

Fifth, privatizations have often been perceived as unfair – rightly or wrongly. Game theory's ultimatum game shows that individuals would rather gain nothing at all rather than agree to a deal in which they feel they gain less than their fair share. This seemingly irrational result, combined with a frequent perception that concessionaires or governments may have benefited disproportionately may be a key part of the privatization paradox (Shirley 2004),

More generally, it is very difficult to determine the gains and losses from any given privatization as neither the population nor researchers have a proper counterfactual against which to judge performance. The implication then for governments is that perceptions of fairness must be carefully managed. That means not only that transactions must be transparent and above board, but that the use made of the proceeds of privatization must be used in a way to offset the possible sense of injustice. In many cases where transactions were in fact clean, governments directed the proceeds of privatization to the general fiscal account, making them “disappear” rather than using them for direct and visible redistribution.

Sources: Adapted from Martimort and Straub (2005) with additional information from Boix (2005).

The critical issues: cost recovery and governments' regulatory and redistributive functions

Critical to the success of PPI are the regulatory regime and cost recovery, or, when cost recovery is either impossible or inappropriate, well designed subsidy policies. At the heart of the problem (insufficient improvement in management of too scarce resources) lies a government failure in its regulatory and re-distributive role. This is a central (and not too original) argument of this report. Fundamentally, the problems remain very similar whether the private or the public sector are delivering a service: if cost recovery is not possible from users, tax payers will have to pay or else assets will be depleted; a natural monopoly requires regulation, whether public or private; re-distributive goals are set by governments regardless of how they are then implemented and funded (again either by tax-payers or by users through cross subsidies.)

PPI sometimes occurred amid incomplete reforms and immature regulatory frameworks

Introducing private participation required sweeping changes in the region's institutional, legal and regulatory frameworks. Alterations were needed both to allow and accommodate private investment, and transform the government's role in many sectors from owner-operator to facilitator, overseer and regulator. Infrastructure services typically satisfy basic needs of the population or are natural monopolies. Because of both these characteristics –the main justifications for government provision in the first place– effective regulation is required to discipline private participants and protect consumers. Regulation is also essential to protect investors from arbitrary or politically motivated intervention from governments, the risk of which is increased by the high sunk costs of many infrastructure projects (which make investors unwilling to withdraw, even if conditions deteriorate).

Reforms typically sought to establish a clear separation of the functions of policymaker, regulator and service provider. Policy making functions usually remain in the appropriate ministry, but new systems of regulatory oversight have been set up. State companies have typically been set on a more independent and commercial footing, with many utilities incorporated as public enterprises (“corporatization”), prior to private participation. Within many sectors, horizontal or vertical unbundling has also occurred, to separate out those activities most suitable for private involvement and to promote competition where feasible. However, in networked industries, the possibilities for competition are limited, and may be restricted to competing for the right to operate a monopoly. Most reform programs have sought to promote efficiency and service quality and reduce costs, in addition to bringing private investment. However, the pattern of change has varied considerably among sectors and countries.

With the benefit of hindsight, it appears that analysts and reformers were overly optimistic regarding their ability to structure the sectors, structure regulation, and set up concessions. Moreover, it was not sufficiently anticipated that regulation could not provide complete insulation from political influence. To function effectively, regulation must be part of a comprehensive package that also includes proper industry structure, technical support, incentives, and well-designed community participation.

There may have been a tendency to adopt models developed for other setting. Thus, the independent water regulator model adopted in Argentina was similar to the British one developed for mature infrastructure network in developed countries. Similarly, many of the regulatory and

pricing models had been developed in situations where the objective was to reduce cost and prices, rather than expand coverage.

The first generation of reforms did not always set up the institutions or policy frameworks needed. Regulatory agencies often lack autonomy, financial, operational and political. Many countries do not even have independent regulators. And ministries may lack capacity for policymaking. Sector laws or overall strategies, while not essential, can be helpful for establishing coherent policies and allocating responsibilities and functions. More critical is a national policy framework for tariffs and subsidies. For example, tariffs for infrastructure services in Mexico are set by a large array of federal, state and municipal stakeholders. In the absence of a national policy framework for tariffs and cost recovery, there is wide variation in tariff levels, tariff structures and cost recovery among sectors and regions.

Insufficient competition policy and the lack of good antitrust agencies are in part to blame for the lack of better results in infrastructure reforms. It is true that some segments of infrastructure sectors are natural monopolies, but most of these sectors have segments that support competition. However, privatized companies have often been left enjoying a dominant position, with insufficient efforts made to level the playing field for new entrants. Furthermore, conflict between sector regulators and competition agencies has become a serious issue. There have been many cases where private firms have tried to merge and the sector regulator and competition agency dispute who should rule for or against these mergers. The lack of dialogue and political pressure has allowed the re-bundling of many services, with a clear impact on actual and potential competition. (This is discussed in the context of the transport sector by Estache and Serebrisky 2004 and telecommunication by Andres, Foster and Guasch (2005).²⁰)

Fiscal and political decentralization has presented challenges for reform and private participation in infrastructure, particularly in WSS. In most countries, the provision of not just WSS, but also public lighting, waste management and, to a lesser extent, public transportation and regional highways, is the responsibility of sub-national governments. While decentralization can increase the effectiveness of infrastructure programs, through better planning and accountability, in practice it has often created further difficulties for private infrastructure investment. The atomization of the industry involved can prevent coherent policymaking across the country (as with WSS). Municipal authorities may lack the technical and legal expertise needed to manage private participation. They usually also have limited access to capital markets, which makes infrastructure financing difficult. Overlapping and conflicting jurisdictions of different levels of government may exacerbate the lack of clear and consistent regulation that exists in many countries, even on the national level. And even where a centralized regulator is in place, its supervisory reach over hundreds of decentralized firms scattered across the country is likely to be limited. Private operators may also face greater payment risk, when dependent (as they usually are) on local governments for revenues. Political and regulatory risks are also likely to be higher (Beato and Vives 2003).

Investors also complain of weak law enforcement and non-payment for services. Major Spanish investors in Latin American infrastructure identify non-payment by customers as a serious problem, particularly for water and electricity services (Analistas Financieros Internacionales 2004). In many countries there appears to be a “culture of non-payment” for services, and distributors may face legal and political difficulties in demanding overdue payments

²⁰ Analyzing the interaction between change in ownership and competition for the fixed telecommunication market, Andres, Foster and Guasch (2005) find that privatization is the determining factor behind most performance improvements. However, competition significantly affects prices.

or cutting supply. Furthermore, illegal connections are common, and local police forces may do little to stop this. In many countries, well-established intermediaries offer illegal connections. Because state utilities often tolerated high levels of non-payment, clampdowns by new operators may be a further factor behind public opposition to PPI. But cost recovery is a chronic problem with utilities (although not for telecom) as discussed below.

Cost recovery has proved elusive²¹

The transition toward cost recovery pricing for water and electricity has been much more challenging than expected. During the 1990s, most Latin American countries passed legislation committing to raising water and electricity tariffs toward cost recovery levels, to reduce the fiscal burden of public services and attract private participation. Ten years on, the goal of cost recovery remains elusive. Inflation and currency depreciation eroded the real gains from tariff hikes, as discussed below, while public perceptions of high tariffs contributed to social discontent. The direct evidence on progress is limited. But a recent survey by regulatory agencies in Latin America concluded that residential water tariffs in 10 large cities on average fall short of full cost recovery by around 30%, while industrial tariffs may exceed cost recovery levels by around 20% (ADERASA data).

Water and electricity tariffs have risen significantly, especially for residential services, but price inflation and currency depreciation have largely offset this. Tariff data from around 15 water utilities serving the region's larger cities²² for the period 1997 to 2003 showed that nominal residential tariffs jumped by an annual average of 8%, while for industrial customers, the annual average increase was 4%. But real residential tariffs climbed by less than 1% per year on average, while industrial ones declined 3% per year. Results are similar for a sample of 13 Latin American electric utilities: average annual tariff hikes for residential service were 22% in nominal terms, but less than 2% in real terms over 1990-2002; nominal increases of 18% for industrial customers translated into an average annual real decline of 1% over the period.

Water and electricity tariffs have risen significantly, especially for residential services, but inflation and currency depreciation have reduced these gains. Tariff data from around 15 water utilities serving the region's larger cities²³ for the period 1997 to 2003 showed that nominal residential (industrial) tariffs jumped by an annual average of 8% (4%). But expressed in US dollars, residential tariffs increased by less than 1% per year on average and industrial ones declined 3% per year. Results are similar for a sample of 13 Latin American electric utilities: average annual tariff hikes for residential service were 22% in nominal terms, but less than 2% in dollars over 1990-2002; nominal increases of 18% for industrial customers translated into an average annual decline of 1% in dollars over the period.²⁴ On the other hand, Andres, Foster and Guasch (2005) find substantial price increases among privatized utilities (although most of the increase occurred in the five years prior to privatization): about 60% for electricity and 116% for water.²⁵

²¹ This section is drawn largely from Foster and Yepes (2005), supplemented with data on the price impacts of private involvement, from Andres, Guasch and Foster (2005).

²² Or nationwide, in the cases of Uruguay and Costa Rica.

²³ Or nationwide, in the cases of Uruguay and Costa Rica.

²⁴ Note that period of analysis include the Argentinean and Brazilian devaluations that may drive the drop of prices in dollars at the end of this period.

²⁵ More precisely, they found that real average prices for electricity distribution for the year of the privatization were more than 45% higher than 5 years previous. However, five years after that the total

Latin America's water and electricity tariffs are the highest of the developing world, and are above the average for upper middle-income countries. Latin America's median water tariffs are twice as high as those in East Asia, Eastern Europe, and the Middle East, and more than six times as high as those in South Asia (see Table 6 below.) And electricity tariffs are about 50% higher than in other developing regions, where the range for typical tariffs is US\$0.04-0.06 per kilowatt-hour. However, average residential water tariffs in Latin America, at US\$0.41 per cubic meter, are still barely 40% of OECD levels, while average electricity tariffs, at US\$0.09 per kilowatt-hour, are around 75% of OECD levels.

Recent falls (in dollar terms) make residential water tariffs unlikely to meet any capital costs in nearly half the sample, but all may cover operation and maintenance. Data is not available to estimate each utility's cost of service. Instead, Foster and Yepes (2005) rely on expert estimates of costs set in US dollars as the basis for determining the extent of cost recovery – admittedly a crude proxy, yet one that can at least inform us regarding cost recovery trends. They find that the real decrease in tariffs from 1997 to 2003 meant that the share of utilities within the indicative range for some degree of capital cost recovery declined from 8 out of 13 to 6, while the number that only could hope to cover O&M, if only partially, increased from 4 to 7. These results are reasonably similar to those available for the wider sample of utilities depicted in Table 6 (but for which data was only available in 2003).

Progress has been much greater in the power sector, where the percentage of utilities whose residential tariffs make a significant contribution to capital costs has almost doubled since the early 1990s, and is now nearly two thirds of the total. The average residential electricity tariff in 19 Latin American countries rose from US\$0.07 to US\$0.10 per kilowatt-hour between 1990 and 1996, falling back down to US\$0.09 per kilowatt-hour by 2002.²⁶ Keeping in mind the limitation of the methodology, this suggests that the share of countries recovering some degree of capital costs rose from one third to about two thirds between 1990 and 2002 and the share of countries with residential electricity service at tariffs below operating and maintenance cost declined from 16% to none over the whole period. Industrial tariffs follow a similar pattern of improvements.

increases of real prices were 10%. In the case of water distribution, these changes were approximately 60% and 35%, respectively.

²⁶ Unweighted average across countries.

Table 6: Overview of average residential water tariffs

	Mean (US\$/m ³)	Median (US\$/m ³)	Percentage of firms with degrees of cost recovery		
			Nil	Partial O&M	Partial capital
Global	0.53	0.35	39	30	30
By income					
HIC	1.00	0.96	8	42	50
UMIC	0.34	0.35	39	22	39
LMIC	0.31	0.22	37	41	22
LIC	0.11	0.09	89	9	3
By region or group					
OECD	1.04	1.00	6	43	51
LAC	0.41	0.39	13	39	48
MENA	0.37	0.15	58	25	17
EAP	0.25	0.20	53	32	16
ECA	0.13	0.16	100	0	0
SAS	0.09	0.06	100	0	0

Source: Foster and Yepes (2004) based on original data from ADB 2001; ADERASA 2003; GWI 2004; NIUA, 1999.

Notes: Average tariffs are based on residential consumption of 15 cubic meters. Data drawn from utilities serving 132 major cities worldwide, broken down as follows: OECD (47), SAS (24), LAC (23), EAP (19), MENA (12), and ECA (6).

Overall, Latin America has the strongest record on cost recovery through residential water charges of any developing region. Its performance is also much better than that of the group of upper middle income countries as a whole (Table 6) In general, there is a strong relationship between cost recovery and the income level of the country: average tariffs rise from around US\$0.10 per cubic meter in low income countries, to US\$0.30 in middle income ones and US\$1.00 per cubic meter in the high income group. The percentage of utilities whose tariffs could make a significant contribution to capital costs rises correspondingly, from less than 5%, to around 30% and 50% in the respective income categories.

Latin America's performance is close to that of the OECD, where cost recovery for water services have also proven elusive. Average residential water tariffs in OECD countries currently stand at US\$1.04 per cubic meter. However, even there, only around half of water utilities have tariffs high enough to make a substantial contribution to capital costs. And the higher costs of service provision in OECD nations means the proportion of utilities whose tariffs can contribute to capital costs is close to Latin America's.

Table 7: Overview of average residential electricity tariffs

	Mean (US\$/Kwh)	Median (Kwh)	Percentage of firms with degrees of cost recovery Nil		
			Partial O&M	Partial capital	
Global	0.08	0.07	15	44	41
By income					
HIC	0.12	0.11	0	17	83
UMIC	0.07	0.06	0	71	29
LMIC	0.06	0.05	27	50	23
LIC	0.05	0.05	31	44	25
By region					
OECD	0.12	0.11	0	17	83
LAC	0.09	0.09	0	47	53
ECA	0.06	0.04	31	38	31
EAP	0.05	0.05	29	65	6
SSA	0.05	0.06	29	71	0
SAS	0.04	0.04	33	67	0

Source: Foster and Yepes (2005).

Notes: Data drawn from 84 countries worldwide, broken down as follows OECD (23), LAC (19), ECA (18), SSA (13), EAP (8), SAS (3)

Electricity tariffs are also closer to cost recovery levels in Latin America than in its developing or upper middle income peers. However, at \$0.09 per kilowatt-hour, residential tariffs are still well below the OECD average of \$0.12 per kilowatt-hour, and cost recovery lags the OECD, where more than 80% of countries have residential tariffs high enough to make a significant contribution toward capital costs. As with water, there is a strong relationship between cost recovery and the income level of the country, although the range of tariffs is much narrower and the absolute extent of cost recovery is far higher for electricity services across the income spectrum. Average residential tariffs for electricity in high income countries are around twice low income ones, against a corresponding ratio of around nine times for water. Average tariffs rise from around \$0.05 per kilowatt-hour in low income countries, to \$0.06-0.07 per kilowatt-hour in middle income countries and \$0.12 per kilowatt-hour in high income countries. The percentage of utilities whose tariffs make some contribution to covering capital costs rises correspondingly from around 25% in low income countries to around 30% in middle income countries, and 80% in high income countries.

Poorly designed social tariffs hinder cost recovery and do too little for the poor²⁷

Cost recovery depends critically on well designed social tariffs. The acceptability and feasibility of raising tariffs high enough to approach cost recovery depends on the existence of social tariff schemes to protect poor consumers. Indeed, social tariff schemes are widespread for water and electricity in Latin America. Note however that even well designed social tariffs are no silver bullets: first, they still leave out the unconnected poor; second, uptake rates for new connections are always much lower for poor households even when connections are subsidized.

Increasing block tariff (IBT) structures are the most common form of social tariffs. However, the effectiveness of IBT is conditional on a close relation between income and consumption. While this is generally true for electricity, it isn't for water, where there is a limited relation between income and quantity consumed. Under IBTs, consumers pay a concessionary rate for the first block of consumption, and increasing marginal rates for additional blocks. In theory, the IBT offers an implicit social safety net as the first block should provide all families

²⁷ This section is drawn largely from Foster and Yepes (2005)

with access to a subsistence level of service at below the full economic cost. It should also still allow utilities to recover the full costs of service provision by charging above cost on higher blocks of consumption.

In the water sector, social tariffs, mostly IBTs, are often badly designed and subsidize ineffectively. Foster and Yepes (2005) found that IBTs were almost universal among 17 Latin American water utilities surveyed in eight Latin American countries. The programs considered also displayed several specific flaws. First, subsistence blocks were generally set too high, at an average of 25 cubic meters per month, at which level most residential consumers benefit from these concessionary ‘subsistence’ rates.²⁸ Second, tariff structures were generally very flat, so that the average tariff only covers full average costs at extremely high rates of consumption. Indeed, in 53% of the utilities considered, the average tariff never rises to the cost recovery benchmark level, so IBTs effectively subsidize all residential water use. Third, fixed charges and high minimum consumption thresholds raise average tariffs for lighter consumers. Of the water utilities surveyed, 94% have fixed charges, averaging US\$2.66 per month, and 40% apply minimum consumption thresholds.

Social tariff programs with socio-economic screening perform somewhat better for water. Three-quarters of utilities in the sample also offered a separate social tariff scheme for customers meeting certain poverty criteria based either on neighborhood or individual characteristics. In most cases, this simply takes the form of a parallel IBT structure offering even more concessionary terms and financed internally by each utility through cross-subsidy arrangements. These social tariff schemes offer an average discount of 67% on what would be paid under the normal residential tariff, but they often do not target well. In Chile, Colombia, Argentina and Paraguay more sophisticated social tariff schemes have developed. However, the estimated error of inclusion ranges from 26% in the Paraguayan project to 51% in Colombia. And the error of exclusion of the poor runs from 13% in Colombia to 96% in Chile.²⁹

There is a much greater variety of tariff structures in use in the electricity sector. While eight countries surveyed use IBT structures, six others rely primarily on linear tariff schedules for residential customers.³⁰ The three utilities serving Buenos Aires are the only ones to offer a declining block structure. Residential tariff structures are almost always based solely on volumetric considerations, with Chile and Uruguay being the only countries that apply time sensitive and load based charging systems to residential customers.

²⁸ Average residential consumption is around 20 cubic meters per month in most of these cities, while benchmark levels of subsistence consumption are 8-16 cubic meters per month. Robles (2001) shows that the IBT structure based on a 15 cubic meter threshold for Paraguay delivers only 20% of subsidy resources to the poor, but that this percentage would rise to 60% if the subsistence threshold was reduced to 5 cubic meters.

²⁹ Or 1% in Colombia and 89% in Chile, if just the connected poor are considered. Errors of inclusion means mistakenly including deserving people, while errors of exclusion means mistakenly excluding deserving people.

³⁰ In these 14 countries, 44 major electric utilities were considered (CIER 2003).

Box 6: Colombia's experience with raising residential water tariffs

In 1994, Colombia passed the Public Services Law, which required reference utility tariffs to raise to full cost recovery levels. The law also limited the extent of cross-subsidies between customers, so that poor households should always pay at least half the full cost of the service, while better-off households should pay no more than 20% above the full cost of service, to finance cross-subsidies to poor households. A two-year deadline was set for the completion of this tariff rebalancing.

However, the tariff increases required to meet these legal goals were extremely large and, moreover, regressively distributed. An increase of 50% was required to bring the reference tariff in line with full cost recovery. Furthermore, as cross-subsidies had historically been much larger than prescribed by law, the tariffs of the poorest households would have had to rise by 400% in real terms.

Given the social and political difficulties entailed, the legal deadline was twice extended, first by five years (from 1996 to 2001 by Law 286/96) and then by a further four years (from 2001 to 2005 by Law 632/01). In the meantime, the requirement for poor households to pay at least 50% of the full cost of service provision was reduced to 30%.

Ten years after the reform law, reference tariffs have now reached cost recovery levels. However, higher-income consumers continue to pay surcharges of 30-60% on their bills, to compensate for the large subsidies still applied to lower income groups. And the broad definition of low income groups used in the Colombian tariff system makes 80% of residential customers qualify to benefit from cross-subsidies. Thus, notwithstanding the progress made towards the tariff objectives established in the 1994 Public Services Law, the water sector continues to make substantial fiscal demands. The Colombian government transferred an average of US\$240 million per year to municipally operated water utilities over the period 1998/01, which accounted for 80% of the resources available for investment in the sector.

Source: Adapted from Foster and Yepes, 2005

Tariffs are generally better designed in the electricity sector. In general, IBT tariffs in electricity have smaller subsistence blocks, with an average value of around 90 kilowatt-hours per month. (Subsistence is usually put at around 40 kilowatt-hours in rural areas or 120 kilowatt-hours in urban zones.) They also tend to have steeper gradients: in nearly half the cases, the average tariff reaches cost recovery levels well within the typical consumption range of a residential household. Finally, electric IBT tariffs tend to have lower and fewer fixed charges and minimum consumption thresholds. Of the electric utilities surveyed, 68% have fixed charges, which average only US\$0.66 per month, while just 11% apply minimum consumption thresholds.

But targeting is still not always effective, even where parallel social tariffs exist. Nine of the countries in the sample offer parallel social tariff schemes, mostly based on IBT structures, even when the main residential tariff is linear (see, for example, Brazil and Colombia). Eligibility for social tariffs is usually confined to households consuming below a certain limit, about 200 kilowatt-hours on average.³¹ But some of these thresholds are set too high, rendering the subsidy programs highly regressive. For example, two social tariff schemes in Guatemala and Honduras include a consumption threshold of 300 kilowatt-hours, nearly three times average household electricity consumption.³² Thus 95% of Guatemalan households and 85% of Honduran households are eligible for the social tariff, so that 60-65% of subsidy beneficiaries are not poor, and 80-90% of subsidy resources are captured by the non-poor. Moreover, only around 50% of

³¹ In a handful of cases additional eligibility criteria are applied based on household characteristics (some Argentine provinces), neighborhood characteristics (Colombia), or whether the family is a beneficiary of other welfare programs (Brazil.)

³² Average household consumption is 102 kilowatt-hours per month in Guatemala and 108 kilowatt-hours per month in Honduras.

poor households in Guatemala and Honduras have an electricity connection, and consequently 55-60% of the poor fail to benefit from the social tariff. However, lower errors of inclusion and a less regressive distributional impact are evident in social tariff programs that employ additional eligibility criteria, such as the socio-economic characteristics of the household (e.g. Argentine provincial social tariff schemes) or its neighborhood (e.g. Colombian cross-subsidy scheme.)

Badly designed cross-subsidization and other social tariffs that cover too many people imply more public support of utilities. This is indeed the case for Colombia (Box 6). In that country, 80% of residential water customers qualify to benefit from cross-subsidies. Thus, despite the progress made towards the cost recovery tariff objectives established in the 1994 Public Services Law, the water sector continues to make substantial fiscal demands. The Colombian government transferred an average of US\$240 million per year to municipally operated water utilities over the period 1998/01, which accounted for 80% of the resources available for investment in the sector. More generally, a narrow base of cross-subsidizers who are over-taxed results in an erosion of the revenue base as the cross-subsidizers opt for self-service (auto-generation or own wells). This is particularly true in the case of water where only about 10% to 15% of the client base is industrial users (as opposed to about 50% in electricity).

KEY CHALLENGES

The key challenges include improving the social and economic returns from infrastructure, better leveraging the private sector, through a better management of PPI, but also raising new financing for infrastructure. These, and the many underlying steps required are discussed in turn.

Improving the social and economic returns from infrastructure

Finding better ways to extend affordable service to the poor³³

Most countries employ considerable subsidies and other programs to promote service expansion, but too many people, especially among the poor, still lack basic services. Access rates have been improving, especially among the poor. But growth rates are slow: on current trends providing safe water to more than 90 percent of the region's population may take another 15 or 20 years. Speeding up service provision to the poor does not necessarily require additional state resources. Rather, more effective use of existing funds is needed, particularly in the case of subsidies. (Mexico, for example, already spends nearly 1 percent of GDP on poorly targeted power subsidies).

For policy purposes it is important to identify whether a household is without a service because this is not available in the community or because it is not affordable or convenient. Expanding coverage requires supply-side interventions, while demand-side measures may be more appropriate for making services affordable and accessible. In Guatemala, for example, around 60 percent of households in the first income decile lived in communities with access to the electricity grid (Estache, Foster and Wodon). But only 30 percent of these households actually use electricity, just half of those that could, suggesting that affordability and other demand-side issues are the main factors preventing connection.

Private operators may have little incentive to expand coverage into poor or rural areas. The true cost of providing service to rural or poor customers is likely to be higher than the tariffs they pay. Extending infrastructure to remote or geographically challenging areas is more technically challenging and therefore expensive. There are higher commercial risks and billing costs associated with recovering revenues from customers with limited ability to pay. Revenues per connection are likely to be lower, as the poor tend to consume less (although for water, the correlation between income and consumption may actually be fairly weak, according to Komives et al., 2005). Note however that the incentives to expand may be different for incumbent providers than for new comers to the industry, which may have a different cost structure and more of a need to expand the client base.

Well designed service obligations and connection targets can ensure that private operators do expand coverage. Governments in LAC have frequently included universal service obligations (USOs) in concessions and other contracts. However, these have often been vaguely worded or impracticable. Limitations in the coverage of the network may make fulfilling the obligation a physical impossibility in the short term. And even in communities already linked to the network, prohibitive connection charges may render a service irrelevant. There is therefore a need for USOs to be clearly specified, including how the obligation is to be financed when consumers lack the ability to pay. Connection targets, if well designed, are often clearer in defining the numbers and groups of customers to be served. But they can only be met if

³³ This section draws heavily on Estache, Foster and Wodon (2002), except where other sources are cited.

customers take up the service, which they may not, due to high connection charges or because, for example, they do not appreciate the wider social benefits of connecting to a sewerage system.

Output-based aid can also be an effective instrument. Several countries in the region have developed programs to deliver subsidies to the private sector to expand networks to rural communities. Concessions are typically awarded to private sector operators on the basis of competitive bidding for the minimum subsidy required per connection, beneath a preset ceiling. Most of the subsidy is usually paid only when services are delivered. Chile has used minimum subsidy concessions since 1994 to expand electricity and public telephone services to rural communities. Peru has such a program for rural payphones, while Guatemala does for electricity. A recent initiative in Paraguay (Box 7) seeks to use output-based aid subsidies to extend water service, the first time such an approach has been used for rural and small town water sector investment. More generally, output based aid is critical for the development of PPPs to improve service to poor households – particularly with credit enhancement to cover the risk of non-payment by government agencies.

Allowing cheaper technologies and a range of service levels can also reduce the costs associated with network expansion, as well as making services more affordable. The key is to avoid prescribing single quality standards, specific technologies, or exclusivity rights to the main operator within the legal and regulatory framework instituted at the time of sector reform. Small operators that receive output-based subsidies in both Chile and Paraguay have had some flexibility regarding the technology used. And in Bolivia, the (much larger) private concessionaire in La Paz and El Alto was allowed to introduce a low-cost technology to make water and sewerage connections more affordable to low-income households, using volunteer community labor to install the system. As a result, the cost of installing water and sewerage systems each fell by about 40 percent. The total savings in connection charges are equivalent to 80 percent of household monthly income of \$122 in poor neighborhoods.

Box 7: Pilot program to use output-based aid for expanding water coverage in Paraguay

Paraguay's *aguateros* -small private water companies- form an important part of the water sector, serving about 9 percent of the total population (or about 17 percent of those with piped water supply.) The companies, which average around 300 connections but may have as many as 3,000, have constructed piped water systems without state funding over the last 20 years, mainly in peri-urban Asunción. A new World Bank-funded initiative seeks to attract *aguateros* and construction firms active in the water sector to unserved rural areas and small towns by providing an output-based aid subsidy, awarded through competitive bidding.

Under the pilot program, communities (through water users associations) contract private operators to build and operate water supply systems under ten-year permits. The subsidy was fixed at US\$150 per connection (much less than the total public subsidy required for new rural connections to the state water utility). Operators bid for the lowest connection charge for new customers. The government's rural water agency SENASA manages the construction phase and acts as an arbiter between the community and the operator during the operational phase. The winning bidder of the first phase, to operate four systems, was awarded a contract in August 2002. A second bidding phase was opened for three towns more in 2004.

Source: adapted from Drees et al (2004)

The cross-subsidization schemes commonly employed to promote affordability have often been badly designed. As discussed above, the cross-subsidization schemes that many utilities employ in LAC tend to target badly, benefiting too many of the non-poor and not enough of the

poor. Indeed, Komives et al. (2005) find that IBTs and volume-differentiated tariffs –the most common forms of cross-subsidization, and of subsidies to utility customers in general–tend to have a regressive impact not just in LAC but worldwide. And while these systems should have the advantage, for governments, of not requiring state funding, as richer customers should be paying more to subsidize the lower rates paid by the poor, average tariff levels have usually been so low that significant state support has been necessary. Such schemes may also provide contrary incentives to operators, for whom it is not worth expanding coverage into poor areas if they may not charge enough to recoup costs.

Changing the tariff structure and the groups to which it applies can better target the poor. Modifying the structure of existing tariffs, (for example by reducing the size of the first subsidized block of an IBT) will slightly improve the targeting performance. However, a progressive distribution is only really possible when a significant proportion of households are not subsidized, which would require a major drop in the consumption thresholds below which many utilities currently subsidize. And this still rests on the assumption that low-income groups do in fact consume less, which is not always clearly the case. A more effective alternative may be to introduce some degree of administrative selection into subsidy allocation. Means-tested subsidies, as used for water subsidies in Chile and Paraguay, have distributed benefits progressively, as has geographic targeting in Colombia, although to a lesser extent. (Komives et al 2005). However, they are more complex administratively as well as costlier. Clearly however, an attempt can be made to piggy back on means testing systems where they already exist.

However, overhauling or abandoning consumption subsidies is likely to be politically difficult. Because most existing electricity and water subsidies tend to benefit too many people, any serious effort to redirect, reduce or eliminate subsidies is likely to raise the bills paid by a significant part of the population, including among the non-poor. This will be unpopular, despite the potential benefits of putting utilities on a better financial footing, including improved service quality and eased fiscal pressure.

Connection subsidies can be an efficient way to help the poor. Consumption subsidies deliver no benefits to unconnected households. As a result, connection subsidies may be a preferable alternative especially in areas where water and electricity services are available but take-up is low. Targeted connection subsidies to households are rare in LAC. But subsidies to utilities (whether explicit or hidden) often reduce initial charges to well below the actual cost for all customers, which has much the same effect, but is a less efficient use of resources in welfare terms, as much of the benefit goes to the non-poor. As with consumption subsidies, means testing (and sometimes geographic targeting) helps improve the targeting performance of connection subsidies. Komives et al. (2005) conclude that the long-term benefits of connection subsidies generally exceed the cost of the connection, largely because networked water and especially electricity tend to be cheaper than the alternatives.

Financing arrangements can also make it easier for low-income groups to pay for connections and services. Many low-income groups lack the savings to pay for connections upfront, and have limited access to credit. Providing credit facilities in tandem with network expansion programs or requiring operators to divide charges into several installments can make connections more attainable. In Colombia, for example, the law requires that connection costs for customers from lower socio-economic groups be spread over three years. Such a system has the advantage of lower financing costs, as the utilities' cost of capital is likely to be much lower than that of poorer customers. And the lack of collateral of many low-income customers need not be an obstacle to borrowing, as the utility can use the threat of service disconnection to enforce loan repayment. Similarly, large and infrequent service bills may be difficult to pay. More frequent

billing, flexible payment plans, pre-payment of services (such as through electricity meters) are among the means of facilitating service.

Improving public infrastructure spending efficiency

Decentralization and participatory planning can make infrastructure spending more responsive to local needs, but only if carefully implemented. Involving stakeholders and final users in the prioritization of infrastructure investments should have the advantage both of tailoring provision to the needs and priorities of particular communities and of encouraging greater “ownership” of the projects. A successful example can be seen in the Peru Rural Roads projects (Box 8). However, increasing the number of players can add to conflicts of interest between government levels, users and taxpayers, which can result in excessive spending or misallocation of resources across districts, as well as making accountability more difficult to enforce. The effectiveness of decentralization and of community-based initiatives therefore depends crucially on an enabling institutional environment. This requires, among other elements, government commitment and much stronger accountability of leaders external to local communities than is often the case in many developing countries.³⁴

Regional approaches can help small countries reduce costs and improve reliability of services. In the case of electricity, prices tend to decrease with size of plants (although size certainly does not fully explain prices) and interconnection can help improve reliability (both of demand and of supply). This was the rationale behind the Central American Interconnection System (SIEPAC) which allowed for the creation of a wholesale electric power market and a regional grid.³⁵ Another option that has been discussed in the context of the Caribbean is regional procurement agencies (Jha 2005).

In many countries, more resources should be spent on maintenance, to make up for past neglect. In LAC as in other developing regions, the maintenance of existing infrastructure has been neglected in favor of starting new, highly visible projects. This is very costly (in addition to having a detrimental effect on the quality of the network). A well-maintained road should last 10 to 15 years before requiring resurfacing, but a lack of maintenance can cause severe deterioration requiring resurfacing in as little as five years. There is a strong case for countries in the region to secure budgetary resources for maintenance, as has been done, for example, through the road fund model, financed by earmarked taxes, in El Salvador and other countries

Reallocating funds from new projects to maintenance could have positive outcomes for GDP in LAC. There is considerable evidence that maintenance has a higher economic return than new public investment, as described by Rioja (2003.) He calculated that reallocating resources worth 1 percent of GDP from total public investment, to roughly double infrastructure maintenance in seven major Latin American countries would have increased GDP by 1.9 percent. (The figure is based on an Easterly and Rebelo (1993) estimate that total public investment in the seven countries was around 6 percent of GDP).

³⁴ These are the conclusions of Estache (2004) from a review of recent literature on decentralization and community-based initiatives.

³⁵ In the case of Caribbean islands where such a system would not work, and it is uneconomical to unbundled vertically, an alternative is to remove exclusivity over new capacity and allow for self generation (Jha 2005).

Public spending efficiency can be much improved through more predictable flows and aggressive procurement practices. Unreliable resources make it difficult to manage an efficient maintenance program. It also makes investments much more costly as disruptions in payment may result in stop and go investment programs. In addition, Governments usually end up paying more than the private sector for the same goods and services – and this applies to infrastructure. An aggressive procurement or competition agency monitoring the behavior of Governments when they contract the private sector can substantially reduce collusion among vendors or corruption in general.³⁶

More use can be made of small-scale local providers and cheaper technologies. Technological advances, such as the development of inexpensive water systems and solar and other electricity generators facilitate small-scale local provision of some services. Micro-enterprises have also been successfully used to “micro-privatize” infrastructure services, including routine road maintenance, in Guatemala, Colombia, Ecuador, and Nicaragua. In the Peru Rural Roads Projects, gravel was chosen over more expensive paving, for road rehabilitation, and local micro-enterprises have been contracted to do the work needed. Similar projects have also been implemented in other countries. In Nicaragua, roads have been resurfaced using concrete blocks (“adoquines”), which are cheaper than regular paving, but are durable and effective.

³⁶ Competition authorities can help avoid (or at least reduce) collusion agreements in bidding processes - for example in a road rehabilitation and maintenance scheme bid out to the private sector and funded by the government. To be effective, competition authorities should be involved early on in the bidding process and should have enough resources and powers to access the information needed to identify the existence of collusion.

Box 8: Peru Rural Roads Projects

Three quarters of Peru's rural population live in poverty, two-thirds of them in extreme poverty. In the rural parts of the Andean mountains, the isolation of the poor caused by non-existent or very inefficient transport infrastructure limits access to local markets, schools and health centers. Since 1995, the Peruvian authorities have successfully designed, and are now implementing, an innovative approach to road management in the poorest areas of rural Peru, with the help of the World Bank and the IADB. The Second Rural Roads Project (US\$50 million World Bank loan approved at the end of 2001) has built on the successes of the first project, expanding its scope and furthering reforms.

The two projects have firstly aimed at empowering the rural poor in the process of selecting those rural roads that should be rehabilitated. About one hundred provincial participatory road plans have been prepared through the organization of community workshops. These plans prioritize among road segments to identify the ones that are most critical to the needs of the poor and most likely to help spur productive activities. The project has been considering all the main transport modes of the rural poor: rural roads as well as pedestrian paths for the extreme poor and even fluvial transport for the communities living in the Amazonian regions. A "local development window" was also created to help identify productive activities that became feasible, thanks to the improvement of transport conditions.

Building on the ongoing decentralization reforms in Peru, the management of rural roads has been progressively handed over to provincial municipalities, along with the corresponding budgetary resources and technical expertise. In all, 38 provincial road institutes have been created, under the authority of provincial road boards which include all the mayors from the province. These institutes contract out the maintenance of the roads to micro-enterprises, created by men and women from the poorest rural communities. This approach has improved the efficiency of maintenance activities and also contributed to developing entrepreneurial capacity in rural areas, as well as reducing poverty. More than 500 micro-enterprises have been created, representing 5,700 employment opportunities for poor men and women (30 percent of the workers are women).

By 2005, 13,000 km of rural roads have been rehabilitated under the projects and are receiving adequate routine maintenance contracted out to micro-enterprises. The technology used for road rehabilitation (gravel roads) was about a quarter of the cost of other alternatives like paved roads and is now considered by communities as a sustainable and cost-effective alternative.

In 2005, the mid-term evaluation of the Second Rural Road Project highlighted the improvement in transport conditions as well as its impact on access to schools and health centers, agricultural productivity and rural income. A better trend in poverty and extreme poverty indicators was also observed in the project zones, compared to the other areas not covered. This effect on poverty is expected to become stronger over time.

Managing PPI better

Getting the sequencing of reform and PPI right

PPI has often not worked well if it has come too early, before adequate legal and institutional frameworks were in place. There is an inherent difficulty here, in that establishing regulatory credibility takes time, and is not simply a matter of setting up the institutions needed. In Colombia, for example, regulation is not bad but still there are many inefficient water companies, for example. Regulation is too new to be trusted and the track record of independent decisions made by the newly created institutions is meager.

Sector restructuring should advance as far as possible prior to concession awards. This provides an opportunity for overhauling and reorganizing the sector, something which becomes much more difficult once private investors have come in, and property rights been established. Sector laws can be an effective way to establish a coherent overall framework for a particular sector, by establishing a clear distribution of functions and responsibilities.

Painful reforms are best implemented well before privatization. There are many cases in LAC where the tariff hikes and job losses implied by reform and reduced subsidies have come to be associated by the public with the move to private ownership. For private involvement to gain public support it is essential that governments make such changes clearly ahead of the concession, and are careful to manage public relations so as to present PPI as neither responsible for ill effects, without creating false expectations.

*A stronger state role: new forms of Public-Private Partnership*³⁷

In the basic version of public private partnerships (PPP), the government contracts with the private sector to deliver services on its behalf. A private sector firm, selected competitively, is created to deliver these services, which often involves building new infrastructure. The firm has to build, operate, maintain, and finance the asset and provide the service for the long term (often 25-30 years) in exchange for recurrent payments from the public sector. At the end of the contractual period the operation of the asset reverts to the public sector. This arrangement will deliver “value for money” if some stringent institutional conditions prevail. First, a credible fiscal space must exist to ensure that government payments are made on time and in full. Second, the judiciary system and dispute resolution mechanisms in place must be solid to deter opportunistic behavior from the contracting parties once the contest has been award.

Fiscal and judicial weakness can undermine this basic model in LAC. The two conditions just laid out are difficult to meet in most Latin American countries. Experience suggests that where the judiciary is weak, strategic investors optimize the combined value of project profits plus the expected value of what could be obtained by beating the granting authority in a legal dispute. By winning a concession contest, the concessionaire purchases the option of obtaining extra profits in contract renegotiation. The key point is that the “right” to be paid extra profits will depend on the investment made by both the government and the concessionaire in more and better legal services. On the other hand, in the same weak legal framework, the “creeping” expropriation of a firm that has made a specific, irreversible investment has often been an issue in concession and regulatory contracts in the region.

To address these problems, a taxonomy of different forms of PPP can be developed and applied on a case-by-case basis. The appropriate model will depend on the fiscal situation of the sector, the degree of contract enforcement and the stand-alone profitability of the project. We can give three examples of PPP forms that may work better than the above-mentioned basic version: (i) profit -sharing may work when the project is highly profitable, but courts cannot be relied upon to protect property rights of private operators (by sharing in the profits, the government has no incentives to expropriate from the investor); (ii) the civil works scheme can be applied when both project profitability and contract enforcement are low, but fiscal space is ample; and (iii) the use of concessions supplemented by exclusive land use rights may fit well for road projects when there is no fiscal space and the project is not profitable, but the courts are credible.

In the case of small countries, regional approaches may help attract higher quality operators as well as reap some economies of scale. C&W is the telephone operator across the West Indies, and although there is not much evidence of economies of scale in telecom, the

³⁷ This section was contributed by Juan Benavides.

regional approach is likely to help the smaller islands get more interest. This approach has not yet been tested in the water sector, but may also be of interest (Jha 2005).

Improving award processes and the design of concessions³⁸

Concessions should be awarded through transparent, competitive processes, with bidding criteria carefully chosen. Direct adjudication and bilateral negotiation to award contracts should be avoided if possible. A single criterion for bidding is usually better, as the use of multiple criteria is less transparent and more susceptible to manipulation, corruption and being contested by losers. Contracts, particularly in the water sector and for toll roads, have most often been awarded either for the lowest proposed tariff or through a points system combining a technical evaluation and the proposed tariff. However, both of these are deficient. Tariffs do not provide a firm basis for a concession because they are usually subject to periodic modification anyway. And technical proposals are unlikely to remain relevant or appropriate of the whole of long concession, and their evaluation is to some degree subjective. It may therefore be preferable to fix tariff levels in advance, along with clear rules on readjustment, and award the concession to the qualified bidder prepared to pay the highest concession payments, or accept the lowest subsidy where the service is loss-making. Pre-qualification processes can be used to eliminate bidders without adequate technical proposals or experience.

Improving concession design will discourage frivolous renegotiation, improve sector performance and identify and allocate risks better. Renegotiation will sometimes be necessary. However, contracts should clearly state the events that would trigger renegotiation, with guidelines about the process and outcomes of renegotiation. Contracts should also specify the events that would lead to tariff adjustments and the extent of the adjustments. The issue of risks is addressed in the next section.

Concession contracts should clearly specify the information to be disclosed periodically. Since the late 1970s, economic theory has been understood by economists as a game between the regulator and the firm in which information – or rather the asymmetry of information between the two sides - plays a key role.³⁹ And while price-cap regulation was initially hailed by many practitioners as a mechanism to free them from the need to rely on detailed information from regulated companies this false perception is rapidly vanishing. The unavoidable need for a reliable information system that allows regulators to fulfill their complex objectives is becoming even clearer (Rodriguez, Schirf, and Groom 2005). Effective regulation requires good, standardized information about the operations of the regulated firm, including on costs, revenues, prices, investments and performance and output indicators. However, contracts have too often been vague about the requirements in this regard, and the data generated has too often been flexibly presented or been of poor quality.

An adequate regulatory accounting system is fundamental, to produce the reliable, standardized and useful information that regulators need to fulfill their duties adequately. Concession contracts should clearly specify the regulatory accounting norms and definitions to be applied. Regulatory accounting should address common questionable practices. These include: excessive management fees (often equivalent to half the firm's net profits), contracting

³⁸ This section draws heavily on Guasch (2004.)

³⁹ For a summary of key theories see Rodriguez, Schirf, Groom (2005).

subsidiaries or related companies to provide services or equipment at above-market prices; inflating investment proceeds; transferring accumulated profits or capital from other areas into the regulated capital base; and valuing privatized assets at replacement cost. However, combating such distortions is extremely difficult, even in OECD countries. Guasch (2004) argues that applying strict regulatory accounting to 1991-1992 reported results would raise the return on capital from 9.7% to 22.5% for UK electricity distributors, and from 0.9% to 18.3% for that countries water service companies.

Managing and allocating risks better⁴⁰

Governments need to focus on improving the risk-return ratio of investment projects to attract private investment, but must be careful with the undertakings they make. For while some guarantees may be needed to attract private investors, governments must be wary both of taking on too much risk and of promising excessive compensation if guarantees are triggered. This requires that contracts need to better identify and allocate the different risks involved. Risk allocation has a major impact on the cost of capital and tariff levels. The two principles guiding risk allocation should be that: (i) the party that is responsible or has more control over the risk factor should bear the risk; and (ii) the party that is more able to bear the risk (less risk-averse) should do so (Guasch 2004).

Project financing generally requires risk protection instruments to make the risk-return ratio attractive to investors in such projects. Project financing structures carry higher risk as lending is provided against the anticipated cash-flows of the project only, with no (or limited) recourse to the project sponsors. And while investors in developing country infrastructure projects have been willing to accept greater risks in order to achieve higher returns, there are some forms of risk that private investors have been reluctant to bear, as they cannot manage them well and significant potential losses may be involved. Table 8 summarizes the main risks present in a typical infrastructure project, and identifies who has usually borne them, and what arrangements or instruments have been used to allocate those risks. However, arrangements have differed between countries and sectors.

Private investors and borrowers are increasingly requiring that regulatory and exchange rate risks, in particular, be transferred to host governments or other third parties. When a government takes on such risks through guarantees or other structures, lenders and investors become exposed to its sovereign risk and the credit rating this implies. This may be unacceptable to international and even local investors, who may be heavily exposed to sovereign risk already, as is the case with many Latin American pension funds and insurance companies as these often invest mostly in government securities. In such situations, guarantees from third parties, including multilateral institutions, are likely to be needed to diversify exposure. This explains why, even in an investment grade country such as Chile, the use of third party guarantees/insurance has been required in most road concessions to cover certain project risks. Such guarantees may also offer the advantage of raising the project's credit rating above the country ceiling.

⁴⁰ This remainder of this section is based on Sirtaine (2005.)

Table 8: Main project risks in emerging market infrastructure

<i>Risk:</i>	<i>Description of risk:</i>	<i>Risk usually borne by:</i>	<i>Instrument to allocate risk:</i>
Construction	Risk of construction cost overrun or delay.	Private sector	Project contract
Operational	Risk of operational cost overrun, substandard operational performance, etc.	Private sector	Project contract
Force majeure	Risk of a natural disaster, etc.	Private sector	Insurance, project contract
Commercial	Risk of insufficient demand, private supplier/purchaser contracts not being honored, etc.	Private sector (sometimes host country partly)	Project contract (sometimes minimum revenue guarantee)
Financial	Risk of interest rate fluctuations, funding risks, etc	Private sector	Project contract, financial structuring
Political	Risk of expropriation, revocation of permits, asset confiscation, currency inconvertibility or non transferability, war, riots, etc.	Host country or third party guarantor	Political risk guarantee or insurance
Regulatory	Risk of changes in laws and regulations, tariff setting rules, taxation, and of public supplier/purchaser contracts not being honored, etc	Host country or third party guarantor	Project contract, partial risk guarantee
Exchange rate	Risk of currency devaluation / depreciation	Host country (sometimes private sector)	Project contract, foreign exchange guarantee, or structured financing.

Source: Sirtaine (2005.)

Enhancing the capacity of regulators and other institutions⁴¹

Stronger regulation can reduce renegotiation and improve sector performance. Where regulatory capacity is weak, highly detailed but more rigid contracts may be appropriate, which require more frequent renegotiation. The absence of an effective regulator may also tempt governments or private operators to behave opportunistically. Effective regulation is critical to good performance wherever industries, whether privately or publicly owned, are monopolistic, and therefore not disciplined by competition.

Reducing regulatory uncertainty can lower concessionaires' cost of capital, which translates into lower required returns on investments. But establishing regulatory credibility takes not just reforms but also time for confidence in new frameworks to be established. But it can bring significant benefits, through allowing lower levels of tariffs or subsidies, as well as higher proceeds to governments from concession awards.

Regulatory frameworks are stronger if they are grounded in laws. There are many examples of governments, particularly incoming administrations, attempting to change existing concessions and regulatory frameworks, often for political rather than technical reasons. Such efforts significantly increase regulatory risk, translating into higher tariffs or lower transfer values. Argentina (water), Bolivia (various sectors), Brazil (water, electricity), Panama (electricity), and Peru (various sectors) are among the countries in which such outcomes have occurred, interfering with budgets, salary scales and the like. However, if regulatory frameworks and agencies are established in laws, rather than decrees, contracts or administrative procedures, they are much more difficult to interfere with.

Regulatory bodies should be independent. To ensure decision-making autonomy from operators, consumer groups and the government, regulatory agencies should have formal

⁴¹ This section and the following one are largely based on Guasch (2004)

detachment from the corresponding ministry, as well as sufficient financial capacity and autonomy. The operating budget should not be assigned as part of the general government budget, but should instead come from a levy on the regulated industry, usually ranging from 0.5 percent to 2 percent of the companies' gross revenues. Terms should not coincide with the election cycle, and regulators should only be removable from office for duly proven neglect, noncompliance, conflicts of interest or immorality.

Accountability is also essential. This requires transparency requirements, open decision-making and publication of decisions and justification for those. Regular public reporting should include information on appeals of regulators' decisions, performance scrutiny by public audit offices, budget scrutiny by the state legislature, and removal from office for misconduct or incapacity. Institutionalizing public hearings and consultation processes will also promote accountability.

Regulatory agencies require competent staffing. Regulatory board members should have appropriate technical expertise, without being engaged in other activities that would represent a conflict of interests. Salaries should be high enough to attract outstanding professionals, even if this means exceeding usual public-sector pay scales.

Small countries can benefit from regional approaches. ECTEL, the Eastern Caribbean Telecommunication authority, is an excellent example of how to promote effective regulation despite limited national capacity (Jha 2005). This model could productively be extended to water and electricity. Within the Caribbean there is ample scope for information sharing and benchmarking across the region's ports, airports and water and electricity utilities. This could be coordinated by the organization of Caribbean Utility Regulators (World Bank 2005b).

There is a need in many countries for capacity-building in ministries and local governments. Ministries need to have the ability to develop sector policy as well as understand, shape and oversee the complex legal, financial and technical aspects of concessions, including risk management. This is especially the case for the regional and municipal authorities that control an increasing share of infrastructure, with advancing decentralization, but which usually have more limited resources and institutional capabilities than national governments. It is also particularly important that competition and antitrust agencies be strengthened in many countries.

The importance of stronger public institutions has increased with the relative growth of concessions and (particularly) PPPs. As well as leaving governments with more residual responsibility, control and influence than asset sales, concessions and PPPs also require a more extensive regulatory role. This is due to the more extensive conditions and obligations involved, which makes the presence of an adequate institutional framework all the more important.

Choosing the right regulatory regime

Past mistakes should inform the design of future concessions. While price caps may have appeared preferable, as they promote efficiency and do not depend so crucially on the quality of accounting and other information provided, they have not been a great success in practice, amid the high-risk, weak-governance environments of many LAC countries. Hybrid – or, in certain cases, rate-of-return - regimes may therefore be preferable, despite the lower efficiency incentives these provide.

Price-cap systems, which create incentives for efficiency in the provision of services, were widely embraced in Latin America. Among more than 1,000 concessions in the LAC region in 1985-2000, 56 percent were regulated under a price cap regime, 20 percent under rate-of-return legislation, and 24 percent under a hybrid system (Guasch 2004). This was in preference to traditional regulation systems, which sought to limit the monopoly profits that firms could make, primarily through rate-of-return regulation. In rate-of-return systems, the regulator sets prices at a level that will cover the firm's operating expenses and capital costs. Besides providing few performance incentives, such systems rely heavily on the quality and accuracy of firms' accounting data, and are susceptible to manipulations of this. Price caps limit the prices that utilities may charge but not their earnings, although the level may be set so as to generate a reasonable return to a model efficient company.

The choice of regime has a significant effect on performance, with price-caps achieving the best results. Estache and Rossi (2004) found that the type of regime under which they operate had a significant impact on the labor productivity of private electricity distributors in Latin America from 1994 to 2001. Those operating under price-cap or hybrid schemes (discussed below) used respectively, about 55% and 25% less labor to produce the same bundle of output, given the capital input, than public firms. Those operating under rate-of-return regulation scored about the same as public firms.

However, price-cap regimes have proved riskier for concessionaires and many have been renegotiated. The higher risk level (because profits are not guaranteed), translates into a higher cost of capital. Frequent renegotiation (discussed above) has undermined these regimes. When renegotiated, such systems have usually been replaced by hybrid arrangements. The newer designs often recognize that some of the cost categories will enjoy automatic or trigger-driven pass-through to users. The specific share of the costs enjoying automatic pass-through (and the degree to which this weakens efficiency incentives) varies across sectors but is largely dominated by activities subject to exchange risks (e.g. imported inputs and foreign debt service) or activities subject to negotiated long-term arrangements (e.g. labor contracts).

Price-caps have not achieved the results expected by users. Efficiency gains have been largely captured by governments or firms, rather than shared with users through lower tariffs. And users have in fact been penalized doubly, relative to rate-of-return regimes, as the higher cost of capital translates into higher tariffs. And renegotiation, as discussed above, has tended to go against consumers, through the lower investment levels and higher tariffs often agreed.

Raising new finance for infrastructure

The scope for further funding through user charge⁴²s

The possibilities for full cost recovery vary across infrastructure sectors and sub sectors. For infrastructure with strong public good characteristics such as rural roads user charges are not a feasible financing mechanism. Only in the telecommunications sector is full cost recovery through user charges not only possible but actually the norm in Latin America. This largely explains why private investment has been easier to attract, and also why governments have sometimes been unwilling to divest "cash cow" companies. For water and electricity, cost

⁴² This section is based on Foster and Yepes (2005)

recovery is technically feasible and economically attractive, but has been difficult, politically and practically, to achieve.

Except in a few countries, affordability does not appear a serious constraint, indicating that there is still room to raise tariffs toward cost recovery levels in LAC. Foster and Yepes (2004) find that only a small segment of the population in Latin America (less than 20 percent) faces genuine affordability problems in paying cost recovery tariffs. The percentage of each country's urban population that would need to spend more than an affordability threshold of 5 percent of income on a utility bill was calculated for different cost levels, on the basis of household income data (Figure 10).⁴³ In low-income countries, such as Bolivia, Honduras and Nicaragua and Paraguay reaching cost recovery tariffs would represent a significant affordability problem, as a utility bill of around \$10 per month is already a substantial burden for 30-50 percent of urban households. But in upper middle income countries such as Mexico and Venezuela less than 10 percent of the population would appear to face genuine problems of affordability at any of the levels considered.

Figure 10: Urban households facing affordability problems by country

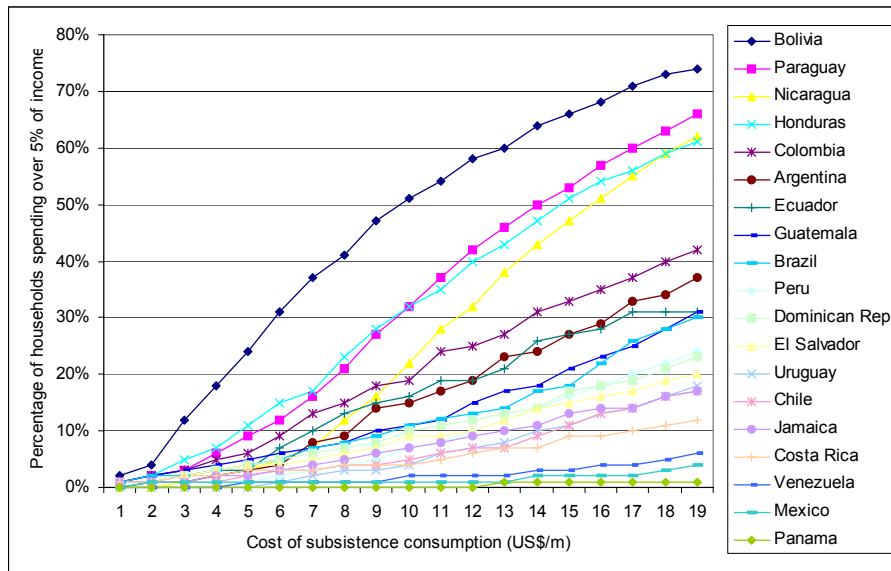

Source: Foster and Yepes (2004)

Affordability is more of a problem when imports weigh heavily in the costs of service provision. In most Latin American countries, the provision of utility services is largely driven by local costs, so it may be more appropriate to consider affordability of subsistence bills in international dollar terms reflecting purchasing power parity, or PPP (Figure 11.) The cost structure of electricity and water services comprises both tradable components, which are better assessed in US dollars, and non-tradable ones. The exact balance between the two is likely to depend on the size and income level of the country. Either way, the majority of households do not face affordability problems.

⁴³ This threshold is often used for water affordability in Latin America, and household survey data suggests that the poorest quintile of households rarely spend more than this level. No comparable benchmark exists for electricity, but household surveys indicate that the bottom quintile rarely spends more than 6-8 percent of income on electricity.

Figure 11: Urban households facing affordability problems by country (PPP)

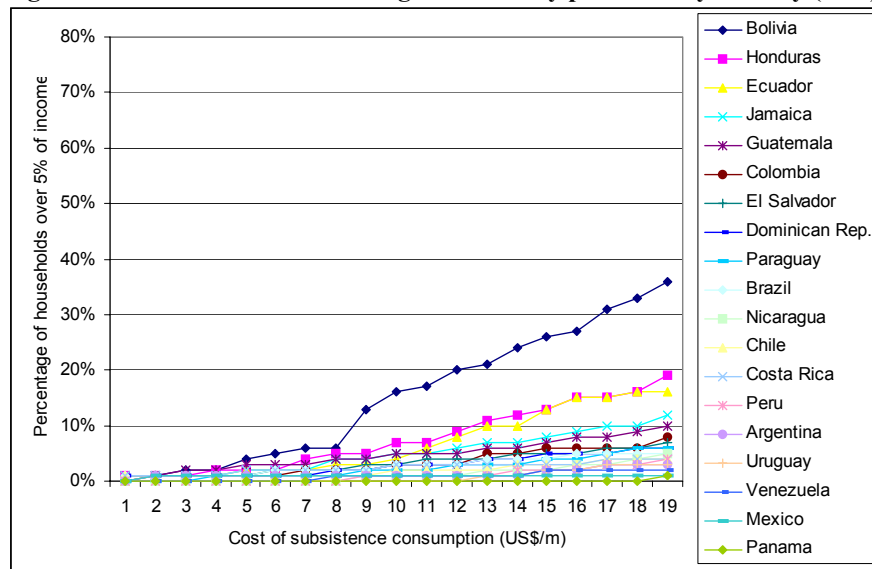

Source: Foster and Yepes (2005)

In either case, affordability problems in Latin America are much more limited than those in other regions with greater prevalence of poverty. When expressed in current US\$ terms, the affordability problem is much more severe in Asia and Sub-Saharan Africa. Whereas only 10 percent of Latin American households would face affordability problems with utility bills at US\$10 per month, around 35 percent of East Asian households and 55 percent of Indian and African households would face affordability problems at the same reference level. Nevertheless, when the same exercise is repeated in PPP terms, the extent of the affordability problem is reduced and the divergences between regions narrow.

Raising tariffs to cost recovery levels would only have a noticeable effect on poverty incidence in a few countries in the region. By raising the cost of essential services, tariff hikes effectively reduce real income, drawing more people under the poverty line, or exacerbating existing poverty. But further analysis of household income by Foster and Yepes (2004) shows that doubling utility bills from US\$3 to US\$6 or US\$6 to US\$12 – two scenarios that might apply in Latin America - does not have a major impact on the region's poverty indices.⁴⁴ The exceptions are countries such as Bolivia and Guatemala, where the headcount poverty rate could rise two percentage points.

⁴⁴ Poverty gap, headcount ratio or FGT index. The headcount ratio measures the percentage of the population under the poverty line; the poverty gap measures the average percentage deviation of the income (expenditure) of those under the poverty line from the level represented by the poverty line; and the FGT index measures the average squared percentage deviation of the income (expenditure) of those under the poverty line from the level represented by the poverty line.

Improving risk coverage, to attract back private investors⁴⁵

To attract both private investors and lenders, changes will be required to traditional project structures and financing, to offer more risk protection where appropriate. Recent crises in emerging markets and the mixed record of infrastructure projects in LAC have made international private investors more risk averse (as discussed above). Such investors typically now apply stricter investment criteria (higher country risk premiums and lower investment concentrations per country), and seek to minimize exposure to currency and government-related risks. They are also increasingly likely to require that government undertakings be backstopped by multilateral agencies or other third parties. The precise risk coverage required to attract institutional investors will depend on each country's circumstances and on each project's characteristics. The higher the political uncertainty, the weaker the regulatory framework, the more volatile the currency, the greater will be the need for political, regulatory and foreign exchange protection respectively. However, governments should be wary of covering risks that are not under their control.

The best way to tackle the problem of currency risk is to draw funding from local sources. Revenues from infrastructure projects are typically in local currency, while private financing must often be serviced in dollars or other foreign currency, a mismatch that represents a significant source of risk. The obvious solution to this is to develop local markets and debt instruments, to generate more sources of funding. (This issue is considered in more depth in the following section.) This process is advancing well in the region, but local funding capacity continues to be limited in the meantime, especially in relation to the enormous financing needs of large infrastructure projects. To address the continuing issue of currency risk on infrastructure investments, multilateral institutions can offer various instruments.

Some local currency funding may be available through IFIs. The IFC offers local currency loans and hedging products to private sponsors investing in developing markets, while the IBRD can offer local currency loans in a number of developing country currencies to governments for investments through public-private partnerships. The IADB is also offering local currency loans to governments in the region, notably Mexico (2004) and Colombia (2005.) However, local currency financing by IFIs is largely dependent on the existence of fairly well established currency swap markets. And the paradox here is that where those exist, such as in Mexico, Brazil and Chile, there is likely to be less need for IFI interventions.

Financing structures can also protect against foreign exchange risks, but effective instruments are still not readily available in LAC. Where local financing capacity is insufficient – where markets are too small or underdeveloped, as in Bolivia, Paraguay or Uruguay, or where the project is particularly large, such as Peru's Camisea – instruments can be used to mitigate foreign exchange risk for private sector players (financiers and sponsors). However, few instruments of this kind are in use, and development banks could do more to develop these instruments. One interesting example is the Liquidity Facility developed by OPIC in 2001 to protect bondholders against foreign exchange risks in an energy distribution project in Brazil (Box 9). The structure, which has not been used again, still has some flaws: in particular, it may not work in cases of extreme foreign exchange shocks. Providing liquidity to the project company would still be of great relief as it would allow operations to continue, although if tariffs are not ultimately adjusted to the new exchange rate, the project company will still not be in a

⁴⁵ This section draws from Sirtaine (2005), with input from Ellis Juan and Jamal Saghir

position to repay its loans. Overall however, it appears as if this liquidity facility may have been a one-off exercise.

Despite their shortcomings, financing structures of this type potentially offer substantial benefits: i) the credit profile of the project company is improved through a significant reduction in the risk of default or renegotiation of the project contract; (ii) the project rating is not constrained by the sovereign ceiling, which may allow the project longer tenor financing at cheaper cost; (iii) linking the project's output prices to the local inflation rate rather than the US dollar exchange rate avoids price shocks for consumers of the basic services provided by infrastructure projects and enhances long-term sector stability; (iv) the financial situation and local currency rating of the output purchaser(s) is not burdened with contractual commitments to purchase the project's output at prices indexed to the dollar; and (v) the cost of the foreign exchange facility is much less than that of a currency swap (in the rare instances in which such swaps are available for a sufficiently long tenor).

Box 9: OPIC's Liquidity Facility to protect bonds in the AES Tiête project, Brazil, from foreign exchange risk

OPIC's Liquidity Facility, developed in 2001, works as a guarantee against foreign exchange risks. It is based on a revolving credit line that becomes available to the project company if a depreciation of the Brazilian Real makes the issuer unable to meet its debt service obligations. A US\$30 million foreign exchange liquidity facility supports a US\$300 million financing.

The coverage in effect establishes a floor in US dollar terms for the company's revenues (earned in local currency). Claims are to be paid when the borrower's revenues are below the floor value, at which point level they would be insufficient to permit payment of scheduled debt service. Coverage is structured to isolate currency risks from operational risks.

The claim is met in the form of a loan subordinated only to the project's senior lenders, with an interest rate that reflects the subordinated nature of the claim. Senior lenders remain exposed to all operational risks. (A pro-forma calculation is performed to determine the extent to which the revenue shortfall is due to currency movements, which give rise to a claim under the devaluation coverage, as opposed to negative operational results, which do not.)

The structure was very well received by rating agencies and institutional investors. AES Tiête became the first electric power project to achieve an investment grade rating in a sub-investment grade country, its bond issue was successfully placed at the longest tenor ever achieved by a Brazilian corporate issuer, and priced to yield 237bps less than Brazilian sovereign debt. That it received a better rating and was placed at a lower yield than sovereign instruments illustrates that the bond was perceived as less risky than other investments in the country, a signal that credit analysts believed that the project had indeed been largely insulated from Brazil's macroeconomic risk.

Source: Sirtaine (2005)

Partial Risk Guarantees (PRGs) from multilateral institutions can protect lenders or bond holders against other perceived risks, providing the credit enhancement that project companies require to raise adequate financing. One such guarantee is the PRG provided by the IFC for a 2003 bond issue by Colombia's Sociedad Acueducto, Alcantarillado y Aseo de Barranquilla (Box 10). Partial Credit Guarantees (PCGs) have also been used extensively by the IFC and IADB to support issuance of long-term local currency bonds in LAC. The credit enhancement provided by such guarantees significantly reduces the cost of debt issued to finance infrastructure projects in LAC, as well as allowing longer tenors, through providing higher credit ratings. And such ratings can open up local capital markets, and a broader range of financial investors, to infrastructure project companies.

Governments can facilitate the access of private infrastructure investors to PRGs by establishing wholesaling facilities for these instruments. A pioneering example of such a mechanism is the Partial Risk Guarantee Facility (PRGF) established in Peru in April 2005 to issue World Bank PRGs in support of Peru's large infrastructure concession program. It aims to maximize the attractiveness of Peru's future infrastructure projects to private investors by protecting private project debt (both bonds and loans) from political and regulatory risk and backstopping government obligations under these PPPs, thus reducing the public contribution required for such projects. World Bank PRGs issued through the facility are set to make financing for infrastructure companies cheaper, longer term, and broader based (in terms of its source.) By encouraging bond issuance and expanding the range of highly rated investment available to institutional investors, the PRGF should also contribute to the development of the local capital market.

Box 10: IFC partial risk guarantee for bond issue by Triple A, Colombia

In 1993, the Sociedad Acueducto, Alcantarillado y Aseo de Barranquilla (Triple A) was awarded a 20-year concession, later extended to 2033, to provide water, sewerage, and solid waste services to the city of Barranquilla, the fourth largest city in Colombia. This concession required the company to extend water and sewerage services in the southwest of the city, which connected 350,000 low-income inhabitants to the network. These investments, through the Suroccidente project, were first financed through short-term and foreign currency debt, which created serious mismatches of maturity and currency on the project company's balance sheet.

In 2003, Triple A wanted to strengthen and stabilize its financial position, so it sought credit enhancement by the IFC to improve the credit rating of a proposed bond issue and allow a bond maturity of up to ten years in the local capital market. The enhancement was in the form of a PRG up to a maximum of 25 percent of the principal amount of the bond issue of US\$63mn equivalent. The bonds were rated AAA on the national rating scale by both Duff and Phelps of Colombia and BRC Investor Services, a three-notch increase over the company's corporate rating. The issue was fully subscribed by over fifteen domestic institutional investors. It was the first bond issue by a Colombian corporate rated below double-A and clearly contributed to the development of the domestic capital market in Colombia.

Drawing more from local capital markets

Most private investment in infrastructure in LAC has come from abroad. In seeking private participation, governments in LAC have focused on attracting foreign investment, largely because underdeveloped domestic capital markets have been unable to generate the significant amounts of long-term capital that major infrastructure projects have required. However, as international investors continue to be reluctant to enter or extend their involvement in Latin America's infrastructure, governments need to tap other financing sources. This is particularly true for smaller-scale projects – including many administered by island states or local authorities in larger countries - that are rarely of interest to international companies. As discussed above, local financing may also be preferable to international investment as it sidesteps the currency risk that can add significantly to the cost of capital of infrastructure projects in LAC by matching the currency of assets (revenue generation) with liabilities.

Local capital markets can potentially provide much more funding, particularly through channeling pension fund resources. Local capital markets remain small in most countries of the region, while savings rates in Latin America have traditionally been low, especially compared

with Asian competitors. But the recent growth across the region of private pension funds - as well as insurance companies, investment funds and other institutional investors - has created a pool of resources that infrastructure projects could tap more. Many institutional investors in LAC have high liquidity levels, and large holdings of government debt and foreign securities, reflecting in part the dearth of attractive local investment alternatives. Domestic institutional investors are often seeking to diversify their portfolios away from sovereign exposure, but have low-risk investment profiles. Infrastructure projects can appeal to them provided the risks are well mitigated, for example through the multilateral guarantees facilities discussed above, and exposures to the government are transferred to third parties. If they can broaden the range of attractive domestic investment options, infrastructure projects offer a way for countries to reduce foreign savings (capital flight), a serious issue in LAC.

Greater efforts are needed to develop the instruments and markets needed to channel local savings into infrastructure investments. Infrastructure bonds should be developed that ideally have long tenors, are denominated in local currency, carry a fixed coupon rate and have limited recourse to sponsors. Instruments such as guarantee facilities, as discussed above, can make local bonds more marketable, as discussed above. Developing foreign exchange derivatives (swaps and forward-related products) will also facilitate funding from abroad.

Bond issues, particularly domestic ones, have played a minor but increasing role in project financing in LAC. Most project finance debt has traditionally come from syndicated bank loans, despite some advantages of debt sales through the capital markets. The total value of infrastructure bond issuance in emerging markets averaged just US\$5 billion a year between 1996 and 2001, or just 6 percent of total infrastructure issuance. However, the value of these emerging markets issues grew at a compounded annual growth rate (CAGR) of 38 percent during the period, against 45 percent for developed markets. Of the 45 new issuers among emerging market infrastructure companies in the period, only 13 were from Latin America.

Chile has been the exception to this, as infrastructure concessions have tapped local debt markets for much of their financing. From 1996 to 2003, infrastructure bonds issued in Chile averaged about US\$1 billion a year, more than half the country's total issuance. However, most of the bonds were issued by established energy corporations, with very few from project companies. When Chilean project companies have attracted significant capital market participation, they have generally benefited from a government minimum revenue guarantee and in some cases a foreign exchange guarantee. In addition, political and regulatory risks had been insured in nearly all cases by a multilateral institution (such as the IDB) or private insurers (such as MBIA). Many of the resources mobilized have come from local pension funds, as discussed in Box 11.

Box 11: Tapping pension funds through bond sales, to finance infrastructure in Chile

To increase investment in infrastructure in the early 1990s, Chile's government introduced a concession program to attract private capital into the transport sector, for roads and highways, bridges, tunnels, and airports. The program has managed to attract over US\$3.6 billion of private investment into infrastructure.

Chile became the first Latin American country to allow pension funds to invest in infrastructure projects. In 1981, Chile had replaced its bankrupt pay-as-you-go retirement system with a fully funded system of individual retirement accounts managed by the private sector. By 2001, more than 95 percent of Chilean workers had joined the system; the pension funds have accumulated \$36 billion in assets; and the average real rate of return has been 10.9 percent per year.⁴⁶ Initially, pension funds were legally constrained from investing infrastructure projects. The lack of investment grade bonds or other financial instruments issued by concession companies was also an obstacle.

In order to facilitate investments from pension funds and insurance companies legal changes to financial and infrastructure regulations were introduced between 1995 and 1996. These reforms, among other things, opened the door for pension funds and insurance companies to invest in bonds without history. As a result of these reforms, a new long-term financial instrument, the Infrastructure Bond, was created. The typical infrastructure bond offering is a 20-year fixed rate bond denominated in Unidades de Fomentos (UFs) – an inflation-adjusted unit of account used in Chile with a AAA local rating and a monoline guarantee. The bonds are sold exclusively to local private investors, including local pension funds and have been oversubscribed in each instance. Of the 16 toll road concessions awarded, 11 have opted to fund through infrastructure bonds, 3 have financed through bank loans and 2 concessions have not yet decided their financing structure.

The development of the infrastructure bond market was assisted by Chile's 1995 achievement of an "A-" credit rating, which created an opportunity for monoline insurance of bond issuances. In November 1998, the consortium handling the upgrade of the Talca-Chillan stretch of the nation's main thoroughfare, Route 5, issued the first US\$150 million in infrastructure bonds. By mid-2002, a total of US\$963 million of infrastructure bonds had been issued in five offerings. The concession program is now being expanded to fund private investment in jails and urban infrastructure.⁴⁷

Source: Jha (2004)

The case for more public investment in infrastructure

Resource needs are significant although they vary according to the goal set. As discussed earlier, for Latin America to reach the infrastructure per capita level of Korea would require investing 4% to 6% of GDP per year over 20 years. About 2% of GDP should suffice for the more modest goal of responding to expected growth in demand from firms and individuals and achieving universal service for water, sanitation and electricity over 10 years. These are lower bound estimates of expenditure needs, however, as they don't include maintenance (which would require an additional 1% of GDP), rehabilitation (which is likely to be substantial but for which we don't have detailed information) or urban transport, ports and airports. Appendix II discusses expenditure needs in more detail.

⁴⁶ For more statistical information on the Chilean system, see the official website of the Superintendencia de AFPs, the Chilean government regulator of the private pension system, at <http://www.safp.cl>.

⁴⁷ <http://www.iadb.org/exr/bs/0603/JDominguez.ppt>

Even if user charges are increased and the private sector brought back in, public investment will still be needed in infrastructure. As discussed above there are limits to user charges, especially in water, most roads and to a lesser extent power. As such, even if the private sector is involved directly or through public-private partnerships, public funding of these sectors will still be needed. Lastly, even in 1998, the peak of private investments in infrastructure, the total value of projects involving private participation (including public commitments) amounted to only about 1.7% of GDP. And in 2003 it was about 0.9% of GDP.

A critical issue is how to generate the fiscal space for such investment. A number of Latin American countries are saddled with serious debt burdens, and those that are not are wary of adopting expansionary policies for fear of a return to fiscal and financial instability. In addition, many countries suffer from great expenditure rigidities leaving very little room to cope with cyclical shocks or to expand investment. In Brazil, for example, over 90 percent of total federal spending is non-discretionary (including wages, transfers to regional governments, interest payments, pensions, and spending on other entitlement social programs.) Rigidities are also high at the sub-national level.

Slashing investment is not an efficient way of controlling expenditures, although it is politically easier. Cuts in investment have long term growth impacts and therefore affect long term solvency as governments' future fiscal revenues are reduced. It is therefore not appropriate to apply the same debt rule to productive and unproductive expenditures (Servén 2005). Of course, not all investments are productive (and not all current expenditures are unproductive) but fiscal rules that apply the same principles to investments and other expenditures will only reinforce the natural bias to cut investments over more politically sensitive expenditures (such as pensions and salaries).

Proposals for increasing fiscal space include the use of alternative rules, an option that has not been endorsed by the IMF. Alternative fiscal rules include the “golden rule” which is used in the UK and which states that over the economic cycle, the government is to borrow only to finance capital and not current expenditures. Another example, used in New Zealand, is “net present value of wealth” accounting which looks at the solvency of the overall public sector. Neither is a panacea however: the first can encourage creative accounting; and the other is complex in its application.⁴⁸ More critically, the IMF, in its board paper on the topic, has categorically rejected the use of these alternative rules.

Other options include allowing exceptions for particular investments, but these are unlikely to be significant. The IMF had suggested looking at various options. One possibility was to exclude commercially run public enterprises from fiscal accounts so as to free them from borrowing ceilings. However, it was found that this would actually reduce fiscal space given that profitable public enterprises are typically used as fiscal cash cows. Another option was to improve the treatment of PPPs to include or exclude them from public accounts as appropriate. Closer analysis showed that better accounting for PPPs would in fact result in reduced fiscal space as more (rather than less) contingent liabilities would be uncovered. A final idea was to make an exception, when calculating fiscal ceilings, for projects financed by multilateral institutions, with the argument that these are more likely to lead to productive investments. While the argument may have merit, total multilateral flows to LAC are less than 1% of GDP and the majority are for non-infrastructure spending, so they are unlikely to solve the problem of fiscal space.

⁴⁸ We are grateful to Luis Servén for his insights on this topic.

The debate continues, as governments in the region need to increase investments. In the longer term, some countries (for example in Central America) with low tax-to-GDP ratios may have the option of raising revenues, but others need to address the issue of expenditure rigidity. In the case of Brazil, where taxes are now a whopping 35% of GDP, an analysis of alternative fiscal rules for infrastructure financing finds that increasing taxes would offset the growth and welfare benefits of increased infrastructure investments. The growth and welfare enhancing scenario is clearly that of a reallocation of consumption expenditures in favor of investments (Ferreira and Nascimento 2005) In addition, the IMF and other institutions are placing more emphasis on the quality of fiscal adjustment. In the shorter term, improvement in the efficiency of public investments may yield some space. Fundamentally, however, governments are left with the need to make politically difficult decisions about the allocation of expenditures.

Improving local governments' access to funding⁴⁹

Local governments' access to private capital depends critically on their credit-worthiness. No amount of credit enhancement or financial engineering can substitute for a sound legal, institutional and regulatory intergovernmental fiscal framework. Factors that often reduce the creditworthiness of local bodies include an inadequate accounting and risk management framework for asset-liability management, lack of autonomous authority to set realistic tax-rates and tariffs or user charges for the basic services they provide and inflexibility in wage structures and hiring-firing policies. Box 12 below provides Fitch Ratings best and worst practices with rating value in terms of the financial management of sub-sovereign bodies. This provides a useful checklist of financial management reforms that local governments can pursue.

Box 12: Best and worst practices with significant rating value for Fitch

Best practices	Worst practices
Cash reserve policy /working capital reserves /budgetary cushions.	Cash basis accounting.
Multiyear financial forecasting.	Qualified audit opinion for material weakness.
Monthly or quarterly financial reporting and monitoring.	Deficit financing for two of last five years.
Contingency planning policies.	Debt retirement speed.
Policies regarding nonrecurring revenue.	Unfunded accrued pension liability.
Depreciation of fixed assets.	Short-term borrowing growing significantly faster than annual spending
Debt affordability reviews and policies.	Debt reprogramming that defers a small share of current debt service.
Pay-as-you go capital finding policies.	Over reliance on nonrecurring revenue.
Debt retirement speed.	Aggressive investment policy for operating funds.
Five-year capital improvement plan integrating operating costs.	Pension contribution deferral in the current budget year.
	Budgetary impasse beyond legal completion date.
	Lack of capital improvement plan.
	Excess borrowing from related entitles, with no capacity to repay in near future.

Source: Fitch Ratings

A major impediment to the development of sub-national credit markets is the moral hazard of a federal government bailout. But implementing a credible no-bail-out policy is easier said than done. Inman (2003) points out that it took about 70 years - and the refusal to bail out eight

⁴⁹ This section is based on a contribution from Abhas Jha with additional inputs from Sirtaine (2005).

defaulting states and the Territory of Florida in the 1840s - for the principle of hard budget constraints for US states and local governments to be generally accepted. Mexico and South Africa have both formulated rules whereby the federal government does not guarantee sub-sovereign debt. In the case of Mexico, the capital risk weighting of bank loans to local governments is linked to local credit ratings. South Africa has established a Municipal Financial Emergency Authority for technical assistance, resources and legal remedies to local governments in distress (Weist 2002). A related legal issue is the need for orderly bankruptcy/ work-out procedures as well as a time-bound procedure for foreclosure. In 1995, Hungary introduced a US style Chapter-11 type bankruptcy procedure to regulate debt clearance procedures in case of default by local governments. Since the law was introduced, eight small cities went through the procedure, and are now in stable financial condition (Noel 2000).

Local and regional governments face additional obstacles when trying to access capital market financing. Weaknesses in the fiscal decentralization framework often limits local government autonomy, imposing large shares of mandated expenditures and limiting freedom to set their own tax rates. Deficiencies in the legal and regulatory framework for sub-national bond issues, such as differential regulatory and tax treatment of sub-national bank lending compared to bond issues, may lead to regulatory arbitrage and distortions in market competition. Similarly, an uneven playing field in sub-national finances may be created by the existence of state managed (and usually subsidized) credit lines and can hamper the emergence of a private sub-national bond market. Finally, most countries in the region have insufficient sub-national bond enhancement instruments.

Structural reforms are needed but, in the meantime, several mechanisms can facilitate access to infrastructure bond markets and other funding for local governments' infrastructure investments. Long-term efforts to ensure sub-national entities have greater access to financial markets require capacity building, governance advisory, regulatory and legal reforms. But, to assist funding in current conditions, multilateral institutions, such as the IBRD, have various instruments allowing countries to borrow, for on-lending to sub-national infrastructure projects for instance, in local currencies. These include: currency conversion options in fixed spread loans, currency swaps and rolling forward. Other instruments, such as the World Bank's municipal fund that provides financing and credit enhancement to sub-national public sector entities, can open up financing alternatives for local infrastructure, even without sovereign support. Its objective is to act as a catalyst to enhance capacity and creditworthiness without central government guarantees.

Pooling credit risk of small and medium local governments offers great potential for enhanced access to infrastructure finance. A common method of credit risk pooling is to set up bond bank that sells its own securities and on-lends the proceeds to local governments. A common feature of all bond banks is that they rely on their member municipal governments to repay their issued debt but also provide a number of credit enhancements to lower the overall cost of borrowing. In Denmark (KommuneKredit) and Sweden (Kommuninvest i Sverige Aktiebolag), the bond bank debt is secured by the obligation of member municipalities to pay the debt, in case an individual member defaults. Japan's Finance Corporation for Municipal Enterprises, Norway's Norges Kommunalbank, and Finland's Municipality Finance Plc are other examples of such pooling mechanisms (Moody's 2001).

Policy-makers can do much to strengthen municipal primary and secondary bond markets. Close to 50% of total US municipal bond issues (75% of BBB, A, or better) are covered by bond insurance (El Daher 1997). Policy makers could consider setting up a bond insurance facility (either in the private or public sector) to facilitate small issuers, considered less creditworthy, to

access the domestic markets for high investment grade debt. Leigland (1997) lists several measures to promote the secondary market in sub-sovereign debt. Among direct measures, countries are exploring ways to facilitate the listing of bonds on domestic stock exchanges and to encourage the development of pre-indication posting or other municipal finance information systems similar to those used in the US to support placement and sales function (e.g. Blue List and Munifax). Amongst indirect measures, removing minimum holding requirements by institutional investors for government securities, including municipal bonds eliminates the bias toward private placement inherent in the system and increases the incentive of institutional investors for trading. Municipal assets are an often underused and overlooked source for enhancement of municipal bonds. Municipalities in China and Poland have used public land as collateral for raising money and then successfully disposing of the assets at higher prices on completion of the project.

The experience with Municipal Development Funds has been mixed. More than 60 countries have set up specialized financial intermediaries or municipal development funds for raising capital to on-lend to sub-national governments. However, very few MDFs have evolved into market-oriented suppliers of credit capable of mobilizing private sector savings (Peterson 1996). Some common features of many successful MDFs (e.g. MUFIS in the Czech Republic and FINDETER in Colombia) include the transfer of credit risk to the private sector, “unbundling” functions like payment collections and credit analysis to specialized private sector firms, separating subsidies from lending and providing technical assistance and capacity building for project preparation. A successful – if unconventional -example of a fund that focuses on capacity building in municipalities is Paracidade in Brazil (Box 13).

Box 13: Paranacidade: Linking municipal finance to capacity building

The state of Parana in the south of Brazil is one of the fastest urbanizing states with 78% of its 9 million people living in 399 municipalities. The municipalities are grouped into 18 regional municipal associations, which are autonomous juridical entities, each electing a regional mayor from amongst the mayors of the member municipalities. Despite such rapid urban growth the state has successfully managed the process of urban development through an innovative institutional structure for managing the process of urban growth called Paranacidade.

Paranacidade was set up in 1996 as a “non-profit corporate legal entity of public interest, classified as Autonomous Social Service,” which operates under contract to the state to provide "institutional and technical services to municipalities in Paraná and to collect and invest financial resources in the state urban and regional development process." It operates in a highly decentralized manner with one central office and five regional offices with a very small and highly qualified staff of about 100.

Paranacidade manages the Fundo Estadual de Desenvolvimento Urbano-State Urban Development Fund (FDU). The FDU makes loans to municipalities with tenors ranging from 8 years for urban infrastructure to 10 years for social infrastructure. It charges a lower than market rate including a 3.5 percent spread over its inflation adjusted cost of borrowing and in the process absorbs the foreign exchange risk. The Fund is made up of the repayment by the municipalities of the first two World Bank projects, Pram and PEDU. In 1988, the state government decided to repay the World Bank out of its own funds and use the repayments coming from the municipalities to set up the Fund. The assets of the Fund today are US\$330 million dollars. The delinquency rate is zero because of stringent debt absorptive capacity criteria for municipalities that are set by the Federal government and also because the state value added tax is intercepted as a guarantee for the loans. Value added tax transfers to the municipalities are escrowed and the bank automatically repays the Fund.

One of the key factors behind the success of Paranacidade has been its support for capacity building for municipalities. It has helped the municipal associations to evolve from political organizations to providers of key technical inputs to municipalities. The associations were outfitted with a small body of technical staff to provide support to municipalities unable to hire specialized personnel on account of their size, or because of scant resources. The urban program further extended these new functions of the associations enabling them to analyze projects valued up to \$200,000, monitor the bidding process, and follow up on works. The association receives a fee for these services. To strengthen the municipalities a broad range of projects have been developed including: tax codes, cadastres, land use plan reviews, hardware and software purchases and cartographic databases. Paranacidade also provides various municipal training programs. The associations' technical staff was trained in project analysis, bidding process, works supervision, borrowing capacity determination, and tax system. The municipalities that already received the cartographic databases were trained in how to use them. Paranacidade has also set up an independent technical audit unit to verify the quality of the works and the accuracy of the measurements and to develop a follow up and monitoring program (SAM) to handle a copious amount of data. All of the associations are now online and connected to the system, and they are transferring information to the database. This makes it possible to track in real time the status of any work, service, or good acquired under the urban program.

Source: Dunin (2000)

Increased local currency financing and better mitigation of foreign exchange risk will be important for enhanced access to capital for sub-nationals. Sub-nationals often lack capacity to manage and mitigate foreign exchange risk. The macroeconomic fragility and external debt overhang of the 1990s has left federal ministries of finance wary of taking on any additional foreign currency denominated debt even more so the contingent claims of sub-national government debt. However local currency debt in Latin America is characterized by short tenors, volatile interest rates and an absence of deep and liquid secondary markets.

Box 14: Local currency financing for Mexico sub-national infrastructure needs

Mexico's Decentralized Infrastructure Reform and Development Project established a facility with IBRD financing of USD 108 million to finance local governments' infrastructure investments in local currency, while passing on the foreign exchange risk to private banks. The facility resembles a line of credit in dollars, to be drawn down, serviced and repaid in pesos. The transaction has a maturity of 18 years, with a three-year grace period, and was structured as follows (and as illustrated in the diagram below):

1. IBRD lends money to two local intermediary banks (Mexico's law requires states to borrow in local currency only and directly from local entities), Banobras and Nafin, for on-lending to states;
2. When the Mexican government submits a request to withdraw funds from the loan (for on-lending to a province), the World Bank Treasury executes, with a market counterparty, an amortizing US dollar (USD) - Mexican Peso (MXP) swap for the same maturity as the loan;
3. The Mexican pesos are then disbursed to Mexico, who then services and repays the amount withdrawn in Pesos;

The pricing charged to Mexico depends on the pricing that IBRD gets from the market at the time each swap transaction takes place; the currency risk is taken by private market players. The funds can be used by creditworthy local governments to finance financially viable projects.

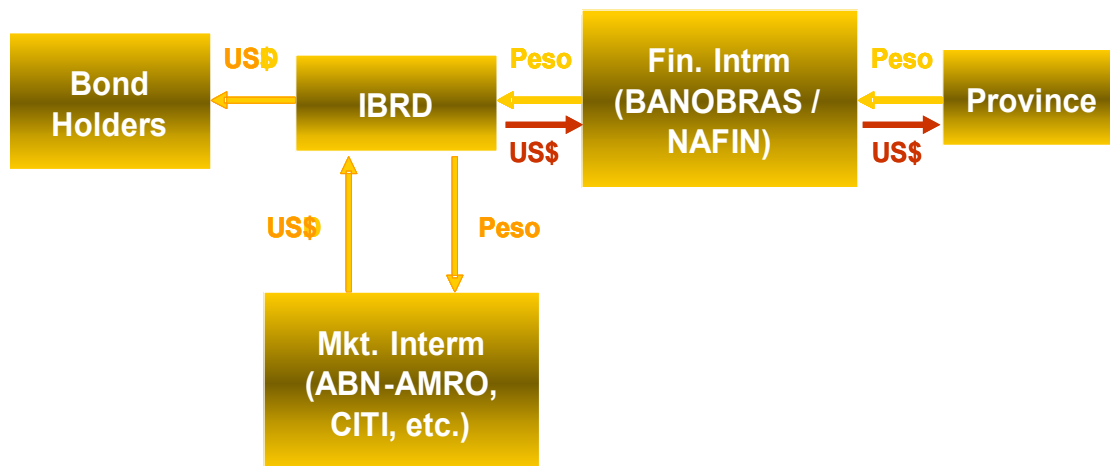

Source: Sirtaine (2005)

Recent developments have improved the outlook for access to finance by sub-national governments. The maturing of the domestic pension fund industry and other institutional investors has created a sophisticated investor class looking for local currency debt instruments all along the yield curve. Sub-nationals offer such investors an opportunity to diversify their portfolio. Countries like Mexico have taken tangible steps to improve their legal and regulatory framework for securitization which mitigates interest rate and credit risk-thus opening up demand from investors previously not interested in simple debt offerings from sub-nationals. Credit enhancements by international financial institutions, such as local currency partial credit guarantees, will further deepen local currency debt markets. Box 14 presents an innovative structure employed in Mexico, to finance local governments infrastructure needs in local currency, while passing on the foreign exchange risk to banks.

REFERENCES

- ADERASA. Forthcoming. "Las Tarifas de Agua y Alcantarillado en America Latina." Grupo Regional de Trabajo Tarifas y Subsidios. PPIAF and World Bank, Washington, D.C.
- Analistas Financieros Internacionales. 2004. "Investor Perceptions of Regulatory and Institutional Risk in Latin America." In J. Benavides, ed. *Recouping Infrastructure Investment in Latin America and the Caribbean: Selected Papers from the 2004 IDB Infrastructure Conference Series.*"
- Andres, L., V. Foster and J. L. Guasch. 2005. "The Impact of Privatization in Firms in the Infrastructure Sector in Latin American Countries." World Bank, Washington D.C. Processed.
- Aschauer, D. 1989. "Is Public Expenditure Productive?" *Journal of Monetary Economics* 23, pp. 177-200.
- Baltagi, H. and N. Pinnoi. 1995. "Public Capital Stock and State Productivity Growth: Further Evidence from an Error Components Model." *Empirical Economics* 20, pp. 351-359
- Beato, P. and A Vives. 2003. "Private Infrastructure Investment at the Sub-national Level: Challenges in Emerging Economies." Inter-American Development Bank, Washington D.C. Processed.
- Blanchard, O. and F. Giavazzi. 2004. "Improving the SGP Through a Proper Accounting of Public Investment." CEPR Discussion Paper 4220. Center for Economic Policy Research, London.
- Boix, C. 2003. *Democracy and Redistribution*. Cambridge University Press, Cambridge.
- Boix, C. 2005. "Privatization and Public Discontent in Latin America." Background paper commissioned for this Report. Inter-American Development Bank, Washington, DC. Processed.
- Brenneman, A. 2002. "Infrastructure & Poverty Linkages, a Literature Review." World Bank, Washington, D.C. Processed.
- Briceño-Garmendia, C., Estache, A. and N. Shafik. 2004. "Infrastructure Services In Developing Countries: Access, Quality, Costs and Policy Reform." World Bank Policy Research Working Paper No 3468, Washington D.C.
- Calderón, C. and L. Servén. 2003. "The Output Cost of Latin America's Infrastructure Gap." In W. Easterly and Servén, Eds., *The Limits of Stabilization: Infrastructure, Public Deficits and Growth in Latin America*. Pp. 95-118. Stanford University Press, Palo Alto, CA and the World Bank, Washington D.C.
- Calderón, C. and L. Servén. 2004a. "Trends in Infrastructure in Latin America, 1980-2001." Policy Research Working Paper Series 3401. World Bank, Washington D.C. Processed.
- Calderón, C. and L. Servén. 2004b. "The Effects of Infrastructure Development on Growth and Income Distribution." Policy Research Working Paper No. 3400. World Bank, Washington D.C.

- Calderón, C., Easterly W. and L. Servén. 2003. "Latin America's Infrastructure in The Era of Macroeconomic Crises." In Easterly and Servén, Eds. *The Limits of Stabilization: Infrastructure, Public Deficits and Growth in Latin America*. Stanford University Press and World Bank, pp. 21-94. Washington D.C.
- Canning, D. 1999. "The Contribution of Infrastructure to Aggregate Output." The World Bank Policy Research Working Paper No. 2246. World Bank, Washington D.C.
- Cashin, P. 1995. "Government Spending, Taxes, and Economic Growth." IMF Staff Papers 42(2), pp. 237-269. International Monetary Fund, Washington D.C.
- Chisari, O., A. Estache, and C. Romero. 1999. "Winners and Losers from the Privatization and Regulation of Utilities: Lessons from a General Equilibrium Model of Argentina." World Bank Economic Review 13(2), 357-78. Washington D.C.
- Chong A., J. Hentshel and J. Saavedra. 2004. "Bundling Services and Household Welfare in Developing Countries: The Case of Peru." World Bank Policy Research Working Paper No. 3310, Washington D.C. Processed.
- De Ferranti, D., G. Perry, F. Ferreira and M. Walton. 2003. *Inequality in Latin America and the Caribbean : Breaking with History?* World Bank, Washington D.C.
- Demetriades, P. and T. Mamuneas. 2000. "Intertemporal Output and Employment Effects of Public Infrastructure Capital: Evidence from 12 OECD Economies." *The Economic Journal* 110, pp. 687-712.
- Dollar, D., M. Hallward-Driemeier, and T. Mengistae. 2004. "Investment Climate and International Integration." World Bank Policy Research Working Paper 3323, Washington D.C.
- Drees, F., J. Schwartz and A. Bakalian. 2004. "Output-Based Aid in Water: Lessons in Implementation from a Pilot in Paraguay." Viewpoint No. 270. World Bank, Washington D.C.
- Dunin, Lubomir Ficinski. "Decentralizing City Management: A Successful Experiment". 2000. The World Bank, mimeo
- Easterly W. and S. Rebelo. 1993. "Fiscal Policy and Economic Growth." *Journal of Monetary Economics* 32(3) pp. 417-458.
- Easterly, W. 2001. "The Lost Decade: Developing Countries' Stagnation in Spite of Policy Reform." The World Bank, Washington DC. Processed.
- El Daher, Samir, "Municipal Bond Markets: Experience of the USA", The World Bank, February 1997, <http://www.worldbank.org/html/fpd/urban/publicat/rd-fm8a.htm>
- Escribano, A. and J.L. Guasch. 2004. "Assessing the Impact of the Investment Climate on Productivity Using Firm-Level Data: Methodology and the Cases of Guatemala, Honduras and Nicaragua." Mimeo. World Bank, Washington D.C.

Escribano, A., Peltier-Thiberge N., L. Garrido and H. Singh. 2005. "The Impact of Infrastructure on Competitiveness in Latin America: A Firm Level Analysis Based on Investment Climate Assessments." World Bank, Washington, D.C. Processed.

Estache A. 2004. "Emerging Infrastructure Policy Issues in Developing Countries: A Survey of the Recent Economic Literature." Background paper for the October 2004 Berlin meeting of the POVNET Infrastructure Working Group. The World Bank, Washington, DC. Processed.

Estache, A. and M. Rossi. 2004. "Have Consumers Benefited From The Reforms In The Electricity Distribution Sector In Latin America?" Policy Research Working Paper No.3420. World Bank, Washington D.C.

Estache, A., Gomez Lobo, A., and D. Leipziger. 2000. "Utility Privatizations and the Poor's Needs in Latin America: Have We Learnt Enough to Get it Right?". In *Infrastructure for Development: Private Solutions and the Poor*. Private Provision of Infrastructure Advisory Facility (PIIAF), Department for International Development (DFID), and World Bank, London.

Estache, A., V. Foster and Q. Wodon. 2002. "Accounting for Poverty in Infrastructure Reform: Learning from Latin America's Experience." World Bank Institute Development Studies, Washington, D.C.

Fay, M. 2001. "Financing the future. Infrastructure needs in Latin America, 2000-2005." Policy Research Working Paper No. 2545. World Bank, Washington D.C.

Fay, M. and T. Yepes. 2003. "Investing in Infrastructure: What is needed from 2000 to 2010?" Policy Research Working Paper No. 3102, World Bank, Washington D.C.

Fay, M., Leipziger D., Wodon Q. and T. Yepes. 2005. "Achieving Child Health-Related Millennium Development Goals: The Role of Infrastructure." Forthcoming in *World Development* 33(8).

Fernald, J.G., 1999. "Roads to Prosperity? Assessing the Link Between Public Capital and Productivity." *The American Economic Review* 89, pp. 619-38.

Ferreira, P.C. and L. Gonçalves do Nascimento. 2005. "Welfare and Growth Effects of Alternative Fiscal Rules for Infrastructure Investment in Brazil." World Bank, Washington DC. Processed.

Fitch Ratings. 2002. "International Rating Methodology for Regional and Local Governments". http://www.fitchratings.com/corporate/reports/report.cfm?rpt_id=141098

Foster, V. and T. Yepes. 2005. "Is Cost Recovery A Feasible Objective for Water And Electricity?" Background paper commissioned for this report. World Bank, Washington, D.C. Processed.

Galiani, S., P. Gertler, and E. Schargrodsky. 2005. "Water for Life : The Impact of the Privatization of Water Services on Child Mortality." *Journal of Political Economy*, Vol. 113, pp. 83-120.

Gannon, C. and Z. Liu. 1997. "Poverty and Transport." TWU Discussion Paper 30. World Bank, Washington DC.

- Graham, C. and A. Felton. 2005. "Does Inequality Matter To Individual Welfare? An Initial Exploration Based on Happiness Surveys from Latin America." Interamerican Development Bank, Washington D.C. Processed.
- Gramlich, E. 1994. "Infrastructure Investment: A Review Essay." *Journal of Economic Literature* 32, pp. 1176–96.
- Guasch, J. L. 2002. "Logistics Costs and Their Impact and Determinants in Latin America and The Caribbean." World Bank, Washington D.C. Processed.
- Guasch, J. L. 2004. "Granting and Renegotiating Infrastructure Concessions: Doing It Right." World Bank Institute Development Studies, Washington, D.C. Processed.
- Guasch, J.L. and P. Spiller. 1999. "Managing the Regulatory Process: Design, Concepts, Issues and the Latin American and Caribbean Story." World Bank, Washington D.C. Processed.
- Guasch, J.L., J. J. Laffont and S. Straub. 2005. "Concession of Infrastructure in Latin America: Government Led Renegotiations." Forthcoming in World Bank Policy Research Working Paper Series. World Bank, Washington D.C. Processed.
- Guasch, J.L., J. J. Laffont and S. Straub. 2003. "Renegotiations of Concession Contracts in Latin America." World Bank Policy Research Working Paper No 3011. World Bank, Washington D.C.
- Harris, C. 2003. "Private Participation in Infrastructure In Developing Countries: Trends, Impacts And Policy Lessons." Working Paper No. 5. World Bank, Washington D.C.
- Heggie, I. and Vickers, P. (1998) – *Commercial Management and Finance of Roads*. World Bank Technical Paper no. 409.
- Holtz-Eakin, D. 1994. "Public Sector Capital and the Productivity Puzzle." *The Review of Economics and Statistics* 12-21.
- Hulten, C. 1996. "Infrastructure Capital and Economic Growth: How Well You Use It May Be More Important than How Much You Have." NBER Working Paper 5847. National Bureau of Economic Research, Cambridge, MA.
- Inman, Robert P. 2003. "Transfers and Bailouts: Lessons from US Federalism", in Rodden, Eskeland and Litvack (Eds.), "*Fiscal Decentralization and the Challenge of Hard Budget Constraints*", MIT Press.
- Jacoby, H. 2002. "Access to Rural Markets and the Benefits of Rural Roads." *The Economics Journal* 110, 713-37.
- Jha, Abhas. 2004 "Use of Pension Funds to Finance Infrastructure in Chile". In "Indonesia: Averting an Infrastructure Crisis: A Framework for Policy and Growth" Pp 96 Box 5.1. The World Bank.
- Jha, Abhas. 2004. "Creating Local Financing Systems for Infrastructure", India Infrastructure Report 2004, Oxford University Press, India.

- Kessides, I.N. 2004. *Reforming Infrastructure: Privatization, Regulation and Competition*. World Bank, Washington D.C. and Oxford University Press, Oxford, UK.
- Komives, K., Foster, V., Halpern, J., Wodon, Q, and R. Abdullah. 2005. "Who Benefits from Utility Subsidies?: Water, Electricity, and the Poor." World Bank, Washington D.C. Processed.
- Krugman, P. "Competitiveness: A Dangerous Obsession." *Foreign Affairs*, March/April, 73-2.
- Leigland, James. "Accelerating Municipal Bond Market Development in Emerging Economies: An Assessment of Strategies and Progress". *Public Budgeting & Finance* (Summer 1997) Vol. 17, issue 2, pages 57-80.
- Loayza, N., P. Fajnzylber and C. Calderón. 2003. "Economic Growth in Latin America and the Caribbean: Stylized Facts, Explanations and Forecasts." World Bank, Washington D.C. Mimeo.
- Lora, E. and U. Panizza. 2002. "Structural Reform in Latin America Under Scrutiny." Research Department Working Paper No. 470. Inter-American Development Bank, Washington, D.C. Processed.
- Manzetti, L. ed. 2000. *Regulatory Policy in Latin America: Post-Privatization Realities*. University of Miami. North-South Press Center. Miami, FLA.
- Martimort, D. and S. Straub. 2005. "The Political Economy of Private Participation, Social Discontent And Regulatory Governance." Background paper Commissioned for this Report. Inter-American Development Bank, Washington, DC. Processed.
- McKenzie D. and D. Mookherjee. 2003. "The Distributive Impact of Privatization in Latin America: Evidence from Four Countries." *Economía* 3(2), pp. 161-233.
- Moody's Investor Services. "Bond Banks Around the World". June 2001
- Navajas, F. 2000. "El Impacto Distributivo de los Cambios en los Precios Relativos en la Argentina Entre 1988-1998 y los Efectos de las Privatizaciones y la Desregulación Económica." In: *La Distribución del Ingreso en la Argentina*. Fundación de Investigaciones Económicas Latinoamericanas, Buenos Aires.
- Noel, Michel, "Building Sub-national Debt Markets in Developing and Transition Countries: A Framework for Analysis, Policy Reform and Assistance Strategy", The World Bank, January 2000, <http://www1.worldbank.org/publicsector/decentralization/noel1.doc>
- Pan-American Health Organization (PAHO) 2002. *Desigualdades en el acceso, uso y gasto con el agua potable en América Latina y el Caribe*. Washington, DC. Available at: <http://www.paho.org/Spanish/HDP/HDD/hdd-agua.htm>
- Peterson, George. 1996. "Using Municipal Development Funds to Build Municipal Credit Markets". World Bank". Mimeo.
- Prud'homme, R. 2004. "Infrastructure and Development." Paper presented to Annual Bank Conference on Development Economics, World Bank, Washington D.C.

- Rioja, F. K. 2003. "Filling potholes: Macroeconomic Effects of Maintenance vs. New Investments in Public Infrastructure." *Journal of Public Economics* 87, 2281-2304.
- Rioja, F. K. 2003. "The Penalties of Inefficiency in Infrastructure." *Review of Development*
- Robles, M. 2001. Simulation of Strategies for Targeting Water and Sewerage Subsidies by CORPOSANA Paraguay, Mimeo, Consultant's Report, World Bank, Washington DC.
- Rodriguez Pardina, M., Schlirf, R., and E. Groom. 2005. "Regulatory Accounting: An Introduction." Macroconsulting, Buenos Aires and World Bank, Washington D.C. Processed.
- Röller, L. H. and Waverman, L. 2001. "Telecommunications Infrastructure and Economic Development: A Simultaneous Approach." *American Economic Review* 91, pp. 909-23.
- Rossi, M. 2004. Ownership and Efficiency: Evidence from Latin American Electric Utilities, Unpublished manuscript. University of Oxford.
- Sanchez-Robles, B. 1998. "Infrastructure Investment and Growth: Some Empirical Evidence." *Contemporary Economic Policy* 16, pp. 98-108.
- Servén, Luis. 2005. "Fiscal Discipline, Public Investment and Growth." World Bank, Washington DC. Processed.
- Shirley, Mary. 2004. "Why is Sector Reform so Unpopular in Latin America." Ronald Coase Institute Working Paper No 4. St. Louis, Missouri.
- Sirtaine, S. 2005. "Financing Sources for Infrastructure Projects in LAC." Background paper commissioned for this report. World Bank, Washington, D.C. Processed.
- Sirtaine, S., M.E. Pinglo, J.L. Guasch and V. Foster. 2005. "How Profitable are Infrastructure Concessions in Latin America? Empirical Evidence and Regulatory Implications." World Bank, Washington D.C. Processed.
- Smith, D., Gordon, A., Meadows, K., and K. Zwick. 2001. "Livelihood Diversification in Uganda : Patterns and Determinants of Change Across Two Rural Districts." *Food Policy* 26, 421-435.
- Standard and Poor's. "The Importance Of Going Local: Shifting Away From Foreign Currency Sovereign Debt In Latin America". Ratings Direct. June 2005
- Strong, J.S., Guasch J.L. and J. Benavides. 2004. "*Managing Infrastructure Investment Risks in Latin America: Lessons, Issues And Recommendations.*" In J. Benavides, ed. *Recouping Infrastructure Investment in Latin America and The Caribbean: Selected Papers From The 2004 IDB Infrastructure Conference Series.* Inter-American Development Bank, Washington DC.
- Weist, Dana, "Framework for Local Borrowing", Decentralization and Intergovernmental Fiscal Reform Course, May 13-15, 2002
- World Bank. 1994. *World Development Report 1994: Infrastructure for Development.* World Bank and Oxford University Press, Washington DC.

World Bank. 2004a. *World Development Report 2005: A Better Investment Climate for Everyone*. World Bank and Oxford University Press, Washington DC

World Bank. 2004b. *Colombia: Recent Economic Developments in Infrastructure (REDI)*. Report No. 30379CO. Washington, DC.

World Bank. 2004c. *The Urban Poor in Latin America*. Report No. 30465. Washington, DC.

World Bank. 2005a. *Project Appraisal Document: Programmatic Power Sector Reform Loan to Dominican Republic*. Report No. 31741-DO.

World Bank. 2005b. *A time to choose: Caribbean Development in the 21st Century*. Washington DC. Available at: <http://web.worldbank.org/WBSITE/EXTERNAL/COUNTRIES/LACEXT/0,,contentMDK:20468612~pagePK:146736~piPK:146830~theSitePK:258554,00.html>

World Development Indicators 2004. World Bank, Washington D.C.

World Health Organization. 2002. *World Health Report*. Geneva.